



Introduction

Before recording

Settings and adjustments for recording

Basic operations

Various recording methods

Menu screen settings

Connecting to a PC

Others

Digital Camera

Model **KY-F70**

INSTRUCTIONS

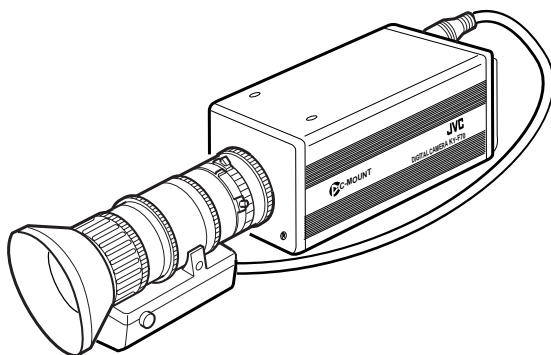

Illustration with optional lens attachment.

For Customer Use:

Enter below the Serial No. which is located on the unit. Retain this information for future reference.

Model No. **KY-F70**

Serial No. _____

This instruction book is made from 100% recycled paper.

Thank you for purchasing the JVC KY-F70 Digital Camera.

The instructions are given in three languages:

English from page 2 to 35

German from page 36 to 69

French from page 70 to 103

Bedienungsanleitung in drei Sprachen:

Englisch: Seite 2 bis 35

Deutsch: Seite 36 bis 69

Französisch: Seite 70 bis 103

Les explications techniques sont données:

Anglais, pages 2 to 35

Allemand, pages 36 to 69

Français, pages 70 to 103

@ @ @ @ @ @

SAFETY PRECAUTIONS

FOR USA AND CANADA



CAUTION: TO REDUCE THE RISK OF ELECTRIC SHOCK, DO NOT REMOVE COVER (OR BACK). NO USER SERVICEABLE PARTS INSIDE. REFER SERVICING TO QUALIFIED SERVICE PERSONNEL.



The lightning flash with arrowhead symbol, within an equilateral triangle is intended to alert the user to the presence of uninsulated "dangerous voltage" within the product's enclosure that may be of sufficient magnitude to constitute a risk of electric shock to persons.



The exclamation point within an equilateral triangle is intended to alert the user to the presence of important operating and maintenance (servicing) instructions in the literature accompanying the appliance.

Information for USA

This device complies with Part 15 of the FCC Rules. Changes or modifications not approved by JVC could void the user's authority to operate the equipment.

INFORMATION (FOR CANADA) RENSEIGNEMENT (POUR CANADA)

- This Class B digital apparatus complies with Canadian ICES-003.
- Cet appareil numérique de la classe B est conforme à la norme NMB-003 du Canada.

Changes or modifications not approved by JVC could void the user's authority to operate the equipment.

WARNING: TO REDUCE THE RISK OF FIRE OR ELECTRIC SHOCK, DO NOT EXPOSE THIS APPLIANCE TO RAIN OR MOISTURE.

This unit should be used with 12V DC only.

CAUTION:

To prevent electric shocks and fire hazards, do NOT use any other power source.

CAUTION:

To prevent electric shock, do not open the cabinet. No user serviceable parts inside. Refer servicing to qualified service personnel.

Due to design modifications, data given in this instruction book are subject to possible change without prior notice.

This unit is designed for professional use only.

WARNING ON LITHIUM BATTERY

The battery used in this device may present a fire or chemical burn hazard if mistreated. Do not recharge, disassemble, heat above 100°C or incinerate.

Replace battery with Panasonic (Matsushita Electric).

CR2032, use of another battery may present a risk of fire or explosion.

- Dispose of used battery promptly.
- Keep away from children.
- Do not disassemble and do not dispose of in fire.

For Sweden

VARNING

Explosionsfara vid felaktigt batteribyte.

Använd samma batterityp eller en ekvivalent typ som rekommenderas av apparattillverkaren.

Kassera använt batteri enligt fabrikantens instruktion.

For Norway

ADVARSEL

Lithiumbatteri – Eksplosjonsfare.

Ved utskifting benyttes kun batteri som anbefalt av apparatfabrikanten.

Brukt batteri returneres apparatieverandøren.

For Denmark

ADVARSELI

Lithiumbatteri – Eksplosionsfare ved fejlagtig håndtering.

Udskiftning må kun ske med batteri af samme fabrikat og type.

Lever det brugte batteri tilbage til leverandøren.

For Finland

VAROITUS

Paristo voi räjähtää, jos se on virheellisesti asennettu.

Vaihda paristo ainoastaan laitevalmistajan suosittelemaan tyyppiin. Hävitä käytetty paristo valmistajan ohjeiden mukaisesti.

Table of Contents

1. Introduction

Features	6
Accessories and attachments	6
Cautionary notes for the correct usage of this product	7
Part names and their functions	8
Explanation of terminals	12

2. Before recording

Basic system 1	14
@ @ @ @ @ @ Basic system 2	15
Inserting the lithium battery	16
Mounting the lens	17
Connecting the power	18
Connecting a monitor	19
Connecting an MO drive unit	20
Connecting a printer	21
Mounting the camera	22
Fall prevention	23

3. Settings and adjustments for recording

Setting the dip switches (Monitor, SCSI ID)	24
Menu settings (VGA model, Lens)	25
Time and date settings	26
Monitor adjustment	28
Focus adjustment	29
White balance adjustment	30
White shading adjustment	32

4. Basic operations

Recording images to the main unit memory	34
Playing back images from the memory	35
Saving images from the memory to an MO disk	36
Outputting images from the memory to a printer	37
Clearing images from the memory	38

5. Various recording methods

Recording a PC monitor	40
Outputting negative images	41
Synchronizing flash and FREEZE	42
About ALC and EEI operations	43

6. Menu screen settings

Menu screen flow	44
Setting procedure	46
EXPOSURE screen	48
WHITE BALANCE screen	51
FREEZE screen	53
PROCESS screen	53
SYSTEM SETTING screen	57
Menu screen of the PLAY mode	59
REC mode quick menu screen	60
Resetting settings	62

7. Connecting to a PC

Compatible systems 1	64
Compatible systems 2	65

8. Others

Specifications	66
----------------------	----

Characters and symbols used in this instruction book

CAUTION	Cautionary notes concerning operation of the unit
MEMO	Reference such as restrictions of features, etc.
	Reference page or item

1. Introduction

Features

- This digital camera uses three 1.45 million pixel 1/2 inch IT CDD.
- Newly developed 1/2 inch C mount Dichroic prism for the color separation prism.
- Capable of recording semi-animation (7.5 frames per second) and still images at resolution of 1360 × 1024 pixels.
- Image capturing capability using a capture board since video signals are processed in real-time by the built-in DSP and outputted as RGN analog signals of 7.5 frames/sec.
- Monitor output can be scan-converted to 640 × 480 pixels for output to a VGA monitor.
- 30 frame/sec. output capability to even a VGA real-time monitor (Draft mode).
- Output digital still images to an MO drive or recommended printer using SCSI connection.
- Export digital still images to a PC using SCSI connection.
- Remotely control your PC using RS-232C connection.

Accessories and attachments

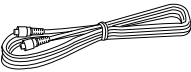

Power cable (2 m)

For connecting with AC adapter 8-pin cable
(☞ page 18)

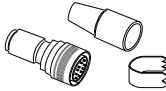

Remote plug (10-pin)

REMOTE terminal plug
(☞ page 12)



Battery

For time and date backup
(☞ page 16)



Ferrite core

For power cable
(☞ page 18)



Mini screwdriver

For replacing battery
(☞ page 16)



PC software (2 types)

- Remote control software
(For controlling the main unit with a PC)
- SCSI import plug-in software
(For importing still images to a PC)

For details, see the instructions attached with the software.
(☞ page 64)



Instruction book

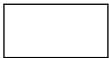

Warranty card



Wire clamp (5 units)

For clamping rear cables, etc.

Cautionary notes for the correct usage of this product

- Before recording an important event, etc., always check to make sure that this product is working properly.
- We are not liable for any missed recordings caused by malfunction of this unit, etc.

■ Phenomena unique to CCD

- **Smearing and blooming**

When using CCD to record a bright light source, a smearing effect may occur running a white line parallel to the light source. In addition, a blooming effect may also occur when the light source is extremely bright, spreading light to the source surroundings.

- **Line distortion**

Line and patterns may appear distorted when recorded.

- **White dots**

White dots may appear on the screen when operating under high temperatures. Always use the product under recommended ambient temperatures.

■ Cautionary notes

- **Influence of strong electric waves and magnets**

Screen noise and discoloration may occur when using the product near antennas of radios and televisions or near transformers, monitors, etc. with strong magnetic force.

- **Compatible lenses** (📄 page 17)

Although the lens mount of this product is a type C mount, take caution as there are restrictions on the lenses that can be used.

This product is not equipped with a back-focus adjustment feature. Please use a lens equipped with the back-focus adjustment feature.

- **Caring of the product (always turn off the power before cleaning)**

Wipe the product with a soft cloth.

Do not use paint thinner or benzine as it may melt or discolor the surface.

For stubborn dirt, wipe with a cloth dampened with water-diluted neutral detergent, then dry wipe.

- This product is a Type II information processing device (information processing device for use in residential areas or nearby areas) conforms to the VCCI (Voluntary Control Council for Interference by Information Technology Equipment) standards for the purpose of preventing electrical interference in residential areas.

However, using the product near televisions and radios may cause interference of reception. Please read the instructions carefully for the correct usage.

Part names and their functions

[Front and bottom]

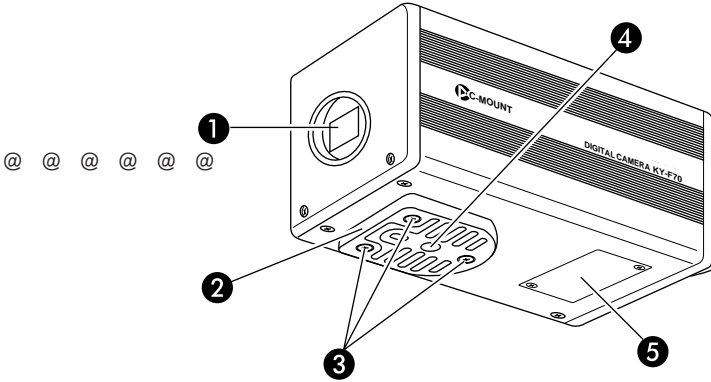

A Lens mount

Although the lens mount conforms to the type C mount lens, there are restrictions on the lenses that can be used.

Mounting the lens (page 17)

B Camera mounting bracket

Although the mounting bracket is mounted on the bottom of the camera when shipped, the bracket can also be mounted on the top of the camera.

Mounting the camera (page 22)

C Locking screws for the camera mounting bracket (M2.6 × 6mm, 3 units)

CAUTION

Always use the attached screws. Using screws that exceed 6mm may result in malfunction of the unit.

D Screw holes for mounting the camera (1/4-inch)

Used when mounting the camera to a fixer or rotating platform.

E Lithium battery case

Used to case the lithium battery for time and date backup. The lithium battery is not installed when shipped.

Please install the attached lithium battery (CR2032) before use.

Inserting the lithium battery (page 16)

[Rear]

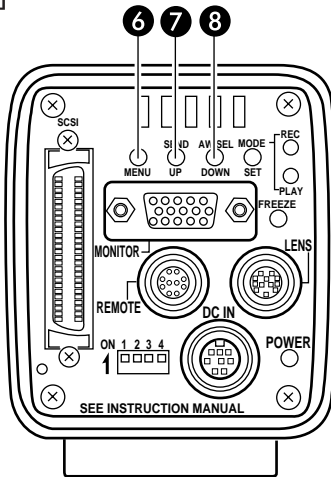

F MENU button

Press this button to output the menu screen from the MONITOR terminal.

Press the button once more to clear the menu screen.

Setting in the menu screen (page 44)

G SEND/UP button

- Press this button to output the same still image* that is being outputted to the MONITOR terminal to an MO drive or printer.

Save images in memory to an MO disk (page 36)

Output images in memory to a printer (page 37)

* A still image refers to an image recorded by pressing the FREEZE button while in the REC mode or an image being played back in the PLAY mode.

- While the menu screen is being displayed, press this button selected item up.

While an item is selected, use this button to change the set value.

Setting in the menu screen (page 44)

H AW/SEL/DOWN button

- [AW (Auto White)]

Press this button to adjust the white balance when the light source of the subject is changed.

White balance adjustment (page 28)

- [SEL (Select)]

Pressing this button each time while in the PLAY mode will switch to the previous image in memory.

* The PLAY mode refers to the condition which the unit is playing back recorded images from the memory.

Playing back images from memory (page 33)

- [DOWN]

While the menu screen is being displayed, press this button selected item down.

While an item is selected, use this button to change the set value.

Setting in the menu screen (page 44)

Part names and their functions (continued)

[Rear (continued)]

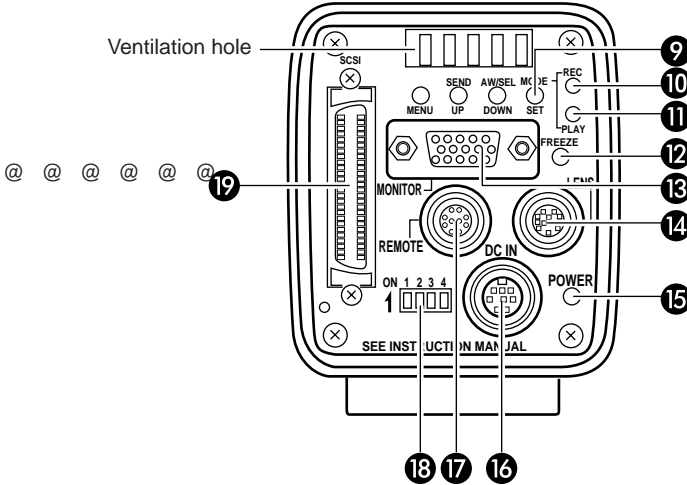

I MODE/SET button

- [MODE]

Pressing this button each time will switch between the REC (record)* and PLAY (playback) modes. The default mode when the power is turned on is REC.

* REC mode is the condition which the unit has either captured an image or is ready to write an image to the main unit memory. Recording images to the main unit memory (☞ page 34)
 Playing back images from the memory (☞ page 35)
- [SET]

While the menu screen is being displayed, use this button to select a submenu or confirm a selected item or set value. Setting in the menu screen (☞ page 44)

J REC display lamp

This lamp lights when in the REC* mode. During FREEZE, this display lamp will flash.

* During the REC mode, camera images are outputted to the MONITOR terminal. Pressing the FREEZE button at this time will save the image to the main unit memory.

K PLAY display lamp

This lamp lights when in the PLAY* mode.

* During the PLAY mode, images saved in the main unit memory are played back by outputting to the MONITOR terminal. Playing back images from the memory (☞ page 35)

L FREEZE button

While in the REC mode, press this button to capture a still image (freeze) of the images being outputted through the MONITOR terminal. At the same time, the still image is saved to the main unit memory. Pressing this button once more will cancel the still image and return to the camera images.

Saving images to the main unit memory ( page 34)

MEMO

You can also set the unit to automatically cancel the still image after 5 seconds.

FREEZE screen, CANCEL screen ( page 53)

M MONITOR output terminal (D-sub 15-pin, female)

Used to connect to a VGA monitor or SXGA compatible capture board.

The default setting is set to VGA monitor compatible. To change the setting from VGA mode to SXGA mode, change the dip switch settings.

Setting the monitor ( page 24)

- When in the SXGA mode, images of 1360 × 1024 pixels (7.5 frames/sec.) are outputted.
- For the VGA mode, you can select between the FINE mode of 640 × 480 pixels (7.5 frames/sec.) or DRAFT mode of 640 × 240 pixels (30 frames/sec.) in the menu screen.

Setting the VGA mode ( page 25)

N LENS connection terminal

Used to connect the lens cable.

Mounting the lens ( page 17)

O POWER display lamp

This lamp lights when the power of the main unit is on.

P DC IN power input terminal (Mini DIN 8-pin, female)

Main unit power supply (DC 12V) is supplied through this terminal.

For the power supply, use the AA-P700 AC adapter.



Connecting the power ( page 18)

Q REMOTE terminal (Metal 10-pin, female)



Used to connect external devices such as a freeze switch or flash unit.

5. Various recording methods ( page 40)

R Dip switches

Used to set the SCSI ID ( page 24) and monitor ( page 24), and output color bar ( page 28).

S SCSI terminal (Half-pitch 50-pin × 2)

Used to directly output to an MO drive ( page 20) or printer ( page 21).

The default setting of the SCSI ID is 7. Change the SCSI ID setting when connecting to a PC, etc.

Connecting to a PC ( page 64)

1. Introduction (continued)

Explanation of terminals

Power terminal (Mini DIN 8-pin, female)

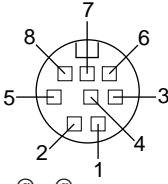

Pin no.	Signal name
1	NC
2	GND
3	NC
4	NC
5	GND
6	12V
7	NC
8	12V

Lens terminal (Metal 12-pin, female)

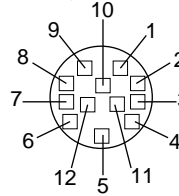

Pin no.	Signal name
1	NC
2	
3	GND
4	NC
5	IRIS CONTROL
6	12V DC
7	IRIS POSITION
8	IRIS AUTO /MANU
9	NC
10	NC
11	NC
12	NC

Remoter terminal (Metal 10-pin, female)

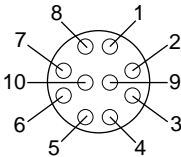

Pin no.	Signal name
1	A. WHITE active $Z_i=22k \Omega$
2	FREEZE L active $Z_i=100k \Omega$
3	WEN L active $Z_o=100 \Omega$ 3V(p-p)
4	FLASH
5	SEND (PRINT)
6	RS-SDI
7	RS-SDO
8	GND
9	12V
10	OPERATION

Terminal name	I/O	Conditions
FREEZE	IN <ul style="list-style-type: none"> 5V CMOS Schmidt Trigger Pull-up to 5V at $100k \Omega$ Input capacity $0.1 \mu F$ 	<ul style="list-style-type: none"> Contact point recommended Rated voltage: 5.3V H level: 3.5 ~ 5.0V L level: 0 ~ 0.8V CMOS (5V): OK TLL not possible
WEN	OUT <ul style="list-style-type: none"> 3.3V (p-p) negative polarity 	<ul style="list-style-type: none"> Output only when in the SXGA mode
FLASH	OUT <ul style="list-style-type: none"> Open collector 	<ul style="list-style-type: none"> Rated current: 150mA Rated voltage: 12V

Monitor terminal (D-sub 15-pin, female)

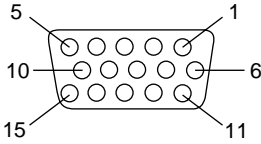

Pin no.	Signal name
1	R OUT 700mV, 75 Ω
2	G OUT 700mV, 75 Ω
3	B OUT 700mV, 75 Ω
4	GND
5	NC
6	R GND
7	G GND
8	B GND
9	NC
10	GND
11	GND
12	NC
13	Hs (3V(p-p) negative polarity Zo=100 Ω)
14	Vs (3V(p-p) negative polarity Zo=100 Ω)
15	NC

SCSI terminal (Half-pitch 50-pin, female)

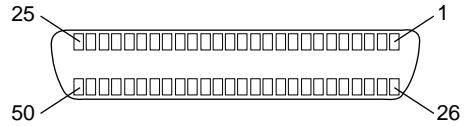

Pin no.	Signal name
1 ~ 11	GND
12	GND
13	NC
14	GND
15 ~ 25	GND
26	DB 0
27	DB 1
28	DB 2
29	DB 3
30	DB 4
31	DB 5
32	DB 6
33	DB 7
34	DBP
35	GND
36	GND
37	GND
38	VC +5 (input only)
39	GND
40	GND
41	ATN
42	GND
43	BSY
44	ACK
45	RST
46	MSG
47	SEL
48	CD
49	REQ
50	I/O

2. Before recording

Basic system 1

While checking the images from the camera on the monitor, output the images to an MO disk or printer.

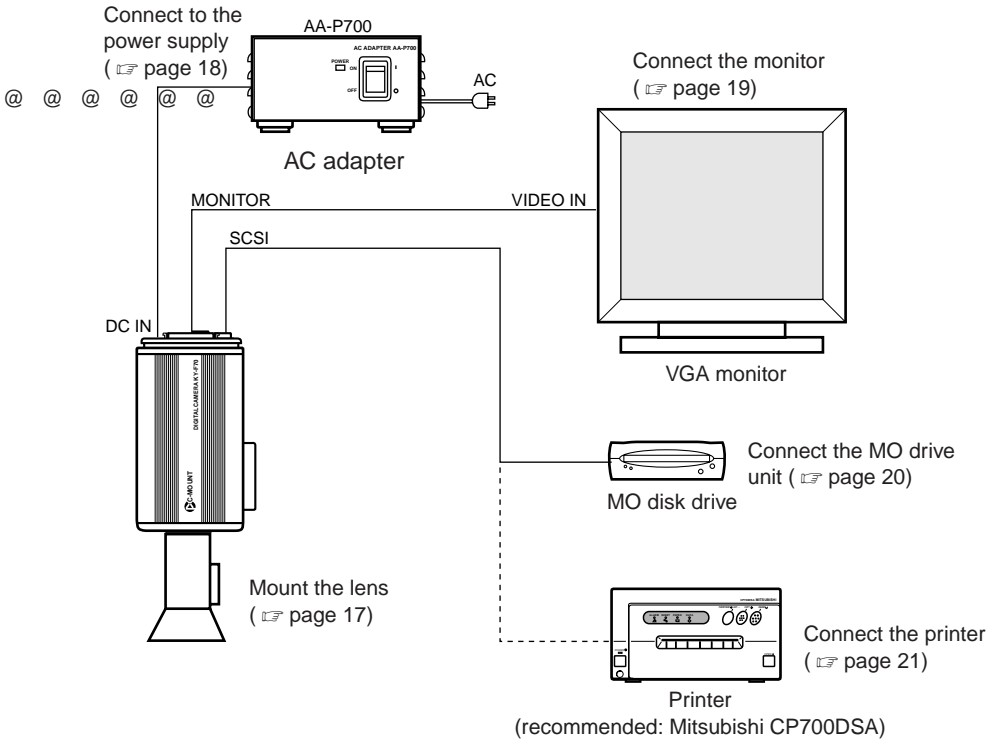

For the power supply, always use the AA-P700 AC adapter.

Basic system 2

This is a system to record with this camera using a flash timed by an external freeze switch.

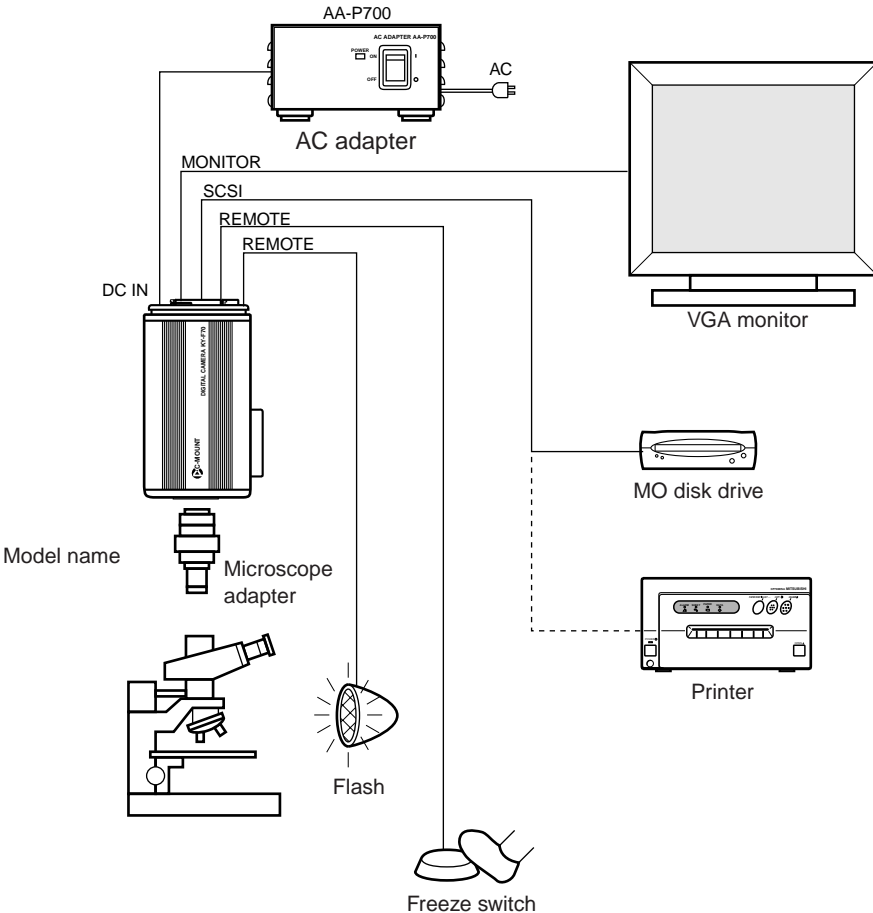

CAUTION

Use a 1/2 inch mount microscope adapter.

To avoid damage to the unit, always use an adapter that is 4mm or less from the lens mount side.

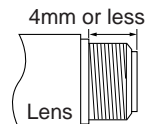

2. Before recording (continued)

Inserting the lithium battery

The lithium battery is used to back up the time and date data.
Install the lithium battery before using the unit.

< Install > Mini screwdriver (attached)

Screws

1.

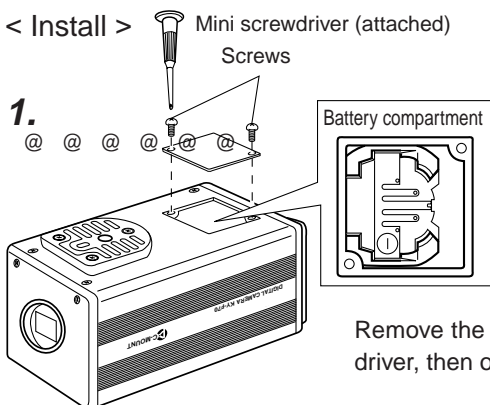

Remove the screws (2 units) using the attached mini screwdriver, then open the cover.

2.

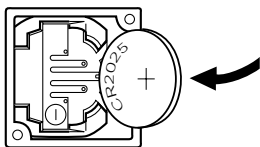

Completely insert the lithium battery in the direction of the arrow with the + side facing up.

3.

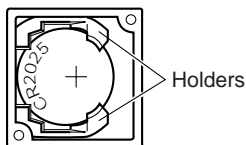

Make sure that the battery is securely in position by the holders as shown in the diagram.

(To remove the battery, follow the procedure in reverse.)

4. Replace the cover and retighten the screws.

MEMO

The time and date will not be displayed correctly when the battery is not installed. When replacing the lithium battery, reset the time and date.

Setting the time and date ( page 26)

Mounting the lens

Follow the procedure shown below when mounting an auto-iris lens. For further details, see the instruction manual of the lens.

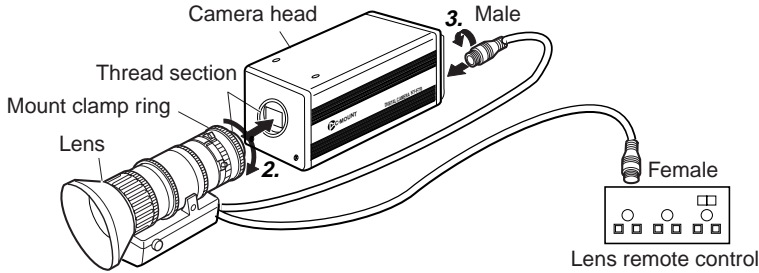

1. Remove the lens mount cap. At this time, take caution so that dust do not enter inside the mount.
2. To mount the lens, lightly press the thread section of the lens mount onto the thread section of the main unit, then turn the mount clamp ring slowly clockwise until it is securely tightened.

MEMO

To change the position of the lens rotation:

- a First, turn the mount clamp ring counterclockwise (1/4 turns) with the lens facing you.
- b Slowly turn the lens and after adjusting the position, retighten the mount clamp ring.

3. Insert the camera cable of the lens into the lens connection terminal on the rear of the main unit, then securely fasten.
The iris control is made automatically from the camera.
* When using a manual iris lens, set the IRIS MODE to MANUAL (see  page 48).
4. When using the lens remote control, connect the lens control cable (female) to the remote control.

CAUTION

Lens is not included with this unit.

To avoid damaging the main unit, make sure that the lens mount of the lens to be used is 4mm or less.

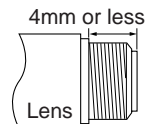

2. Before recording (continued)

Connecting the power

Connect the DC IN terminal on the rear of the main unit and the TO CAMERA terminal of the AC adapter (AA-P700) with the attached power supply cable (2m).

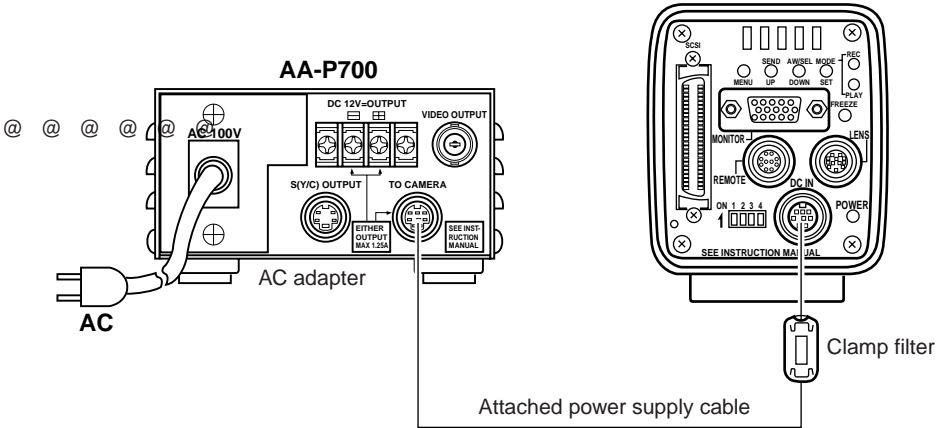

Before connecting, make sure that the power switch of the AA-P700 is set to OFF. Connecting with the power turned on may result in malfunction.

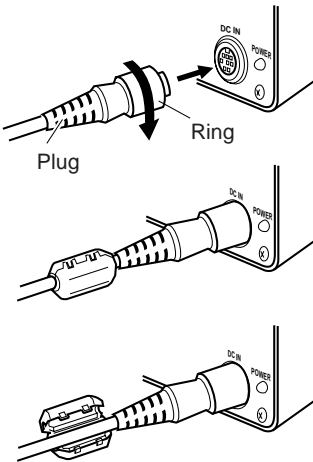

After inserting the plug completely, securely fasten by turning the ring.

To reduce emission of unwanted electrical waves, mount the attached ferrite core as shown in the diagram on the left.

Mount the ferrite core as close to the main unit as possible as shown in the diagram.

Connect the plug to the AC adapter side in the same manner.

Connecting a monitor

Connect the PC monitor (VGA) to the MONITOR terminal on the rear of the main unit.

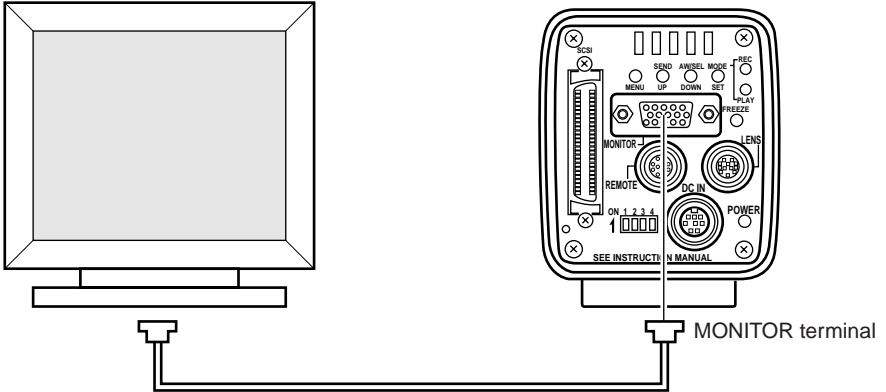

- Before connecting, make sure that the power of all systems are turned off. Connecting with the power turned on may result in malfunction.
- For the connector, commercially available VGA video cable is recommended.
- For the pin assignment, see page 13 Explanation of terminals

2. Before recording (continued)

Connecting an MO drive unit

It is possible to output image data stored in the main unit memory to an MO drive unit. ( Page 36 Saving images from the memory to an MO disk)

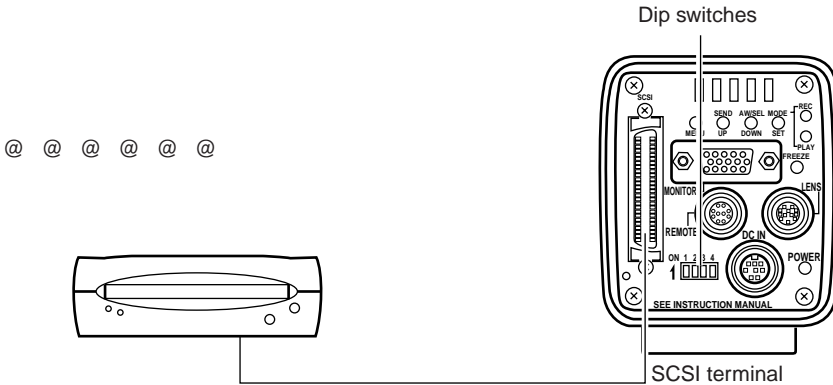

To directly connect the MO drive to the main unit, set the dip switches on the rear of the main unit as shown below.

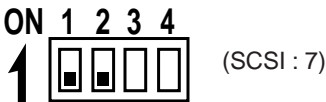

Do not set the ID of the MO drive side to other than 7.

MEMO

- The image data outputted to an MO drive will be 1360×1024 pixels, regardless whether the monitor in use is VGA or SXGA, or whether the VGA mode is set to FINE or DRAFT.
- The maximum allowed length of the SCSI cable is 3m.
- When connecting an MO drive to a PC, separate setting of the SCSI ID is required. ( Page 64 7. Connecting to a PC)
- It is not possible to simultaneously output the image data to a printer and MO drive.

Connecting a printer

It is possible to directly output image data stored in the main unit memory to a printer. ([Page 37](#) Outputting images from the memory to a printer)

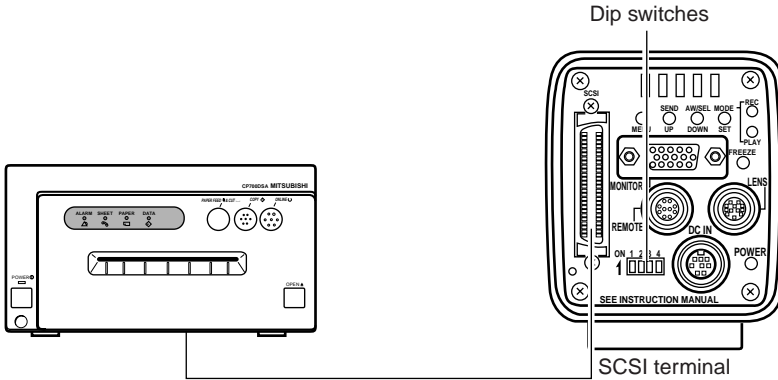

When directly connecting the main unit to a printer, set the dip switches on the rear of the main unit as shown below.

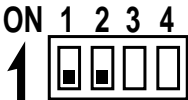

(SCSI : 7)

Set the ID of the printer side to other than 7.

MEMO

- The image data outputted to a printer will be 1360 × 1024 pixels, regardless whether the monitor in use is VGA or SXGA, or whether the VGA mode is set to FINE or DRAFT.
- The maximum allowed length of the SCSI cable is 3m.
- When connecting an MO drive to a PC, separate setting of the SCSI ID is required. ([Page 64](#) 7. Connecting to a PC)
- It is not possible to simultaneously output the image data to a printer and MO drive.

2. Before recording (continued)

Mounting the camera

< Mounting method >

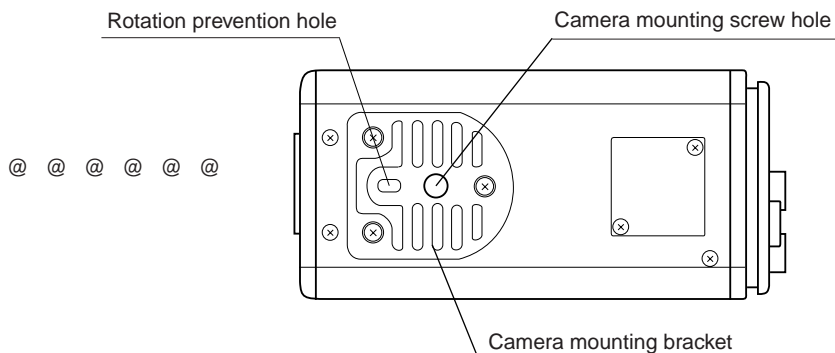

- When mounting the camera, use the camera mount screw hole located on the camera mounting bracket.
- When mounting the camera, use the rotation prevention hole to prevent the unit from falling and securely mount the unit.

< Changing the camera mounting bracket position >

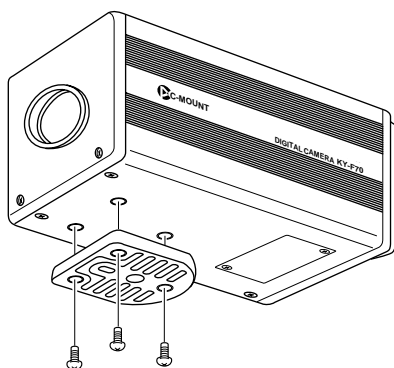

When shipped, the camera mounting bracket is mounted on the bottom of the unit. To mount it on the top of the unit, simply remove the 3 locking screws holding the camera mounting bracket.

CAUTION

Always use the screws mounted on the main unit. Using screws that exceed 6mm in length may result in damage to the unit.

Fall prevention

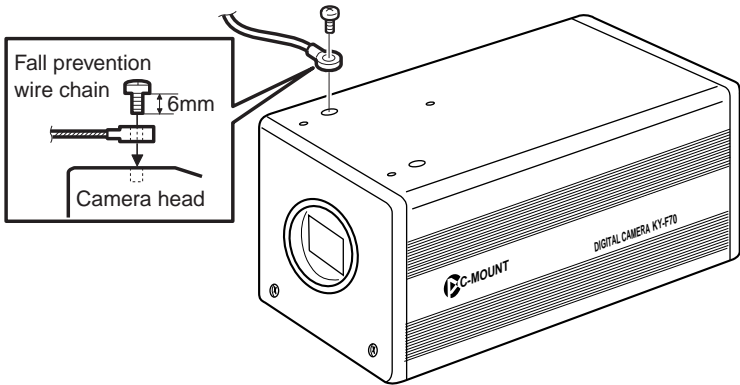

Notes

- Special attention is required when mounting the unit to the wall or ceiling. Rather than attempting to do it yourself, request a qualified person to perform such installation. Falling of the unit may result in bodily injury.
- To prevent the unit from falling, connect the unit to a strong surface with a wire chain, etc. When connecting such chain, use the bracket locking screw hole on the side which the camera mounting bracket is not mounted. (M2.6 × 6mm)

Take special caution to the length of the wire as well.

3. Settings and adjustments for recording

Setting the dip switches

The type of PC monitor to use and the ID during SCSI connection are set using the dip switches.

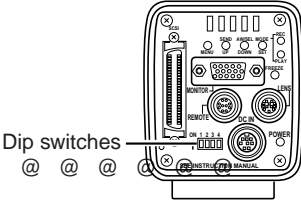

MEMO
 Turn the power off before setting the dip switches. Setting the switches with the power on will not change the settings.

Monitor settings

Dip switch no. 3 is set depending on whether the PC monitor being used is a VGA monitor or a SXGA monitor. <Default setting: OFF>

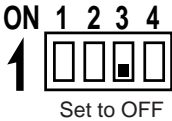

VGA output terminal

Set when directly connecting a VGA monitor to the MONITOR terminal on the rear of the main unit.

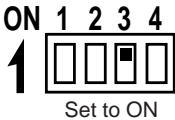

SXGA output setting

Set for systems using a SXGA monitor.

The signal from the MONITOR terminal on the rear of the main unit is inputted through the analog input compatible video capture board. (Page 65 Compatible systems 2)

SCSI ID settings

Sid switches 1 and 2 are set depending on the used system to set the SCSI ID. <Default ID: 7>

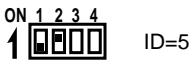
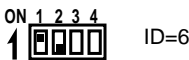
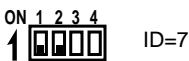

Set when connecting a printer or MO drive directly to the main unit. When making this setting, the main unit will become the host (initiator).

Set when exporting images to a PC.

Make sure that the ID numbers of the connecting devices are not the same.

When making this setting, the PC will become the host (initiator) and the main unit will become the target.

(Page 64 Connecting to a PC)

Menu settings

VGA mode and lens settings are made from the menu screen.

VGA mode settings

Set whether to output semi-animation (7.5 frame/sec.) of 640×480 pixels or full-motion video (30 frames/sec.) of 640×240 pixels to the connected VGA monitor.

```
--- SYSTEM SETTING ---
ON SCREEN      :MEMORY NUM
FRZ DISPLAY    :ON
SEND PRIORITY  :MO
MONITOR        :FINE
BAR LEVEL      :0.7V
NEGA           :OFF
MENU RESET     :
VIDEO MEMORY CLEAR :
TIME ADJUST
```

Set MONITOR in the SYSTEM SETTING screen.

FINE: Semi-animation (7.5 frames/sec.) of 640×480 pixels

DRAFT: Full-motion video (30 frames/sec. of 640×240 pixels

(Default setting: DRAFT)

MEMO

This menu item will be displayed with when set to the SXGA mode by the rear dip switches, disabling changes.

Lens settings

Set whether the used lens is an auto-iris lens or a manual lens.

```
--- EXPOSURE ---
IRIS MODE      :AUTO
AE LEVEL       :0
IRIS LEVEL     :128
IRIS DETECT    :NORMAL
IRIS AREA      :FULL
SHUTTER        :STEP
SPEED          :1/8
SENSCETIVITY   :STEP
LEVEL          :ISO100
ALC MAX        :ISO400
```

Set IRIS MODE in the EXPOSURE screen.

AUTO: Set when using an auto-iris lens

MANU: Set when using a manual lens or no lens.

(Default setting: AUTO)

3. Settings and adjustments for recording (continued)

Time and date settings

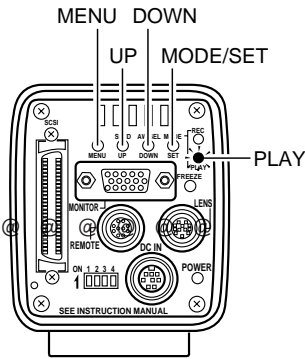

1. Press the MODE button to enter the PLAY mode (PLAY LED on), then press the MENU button. The PLAY menu screen will be outputted through the MONITOR terminal.
2. Press either the UP or DOWN button and select TIME ADJUST (when selected, the TIME ADJUST display will become purple). Next, press the SET button to display the TIME ADJUST screen.
(The TIME ADJUST screen can also be displayed by selecting TIME ADJUST in the SYSTEM SETTING screen of the REC mode.)

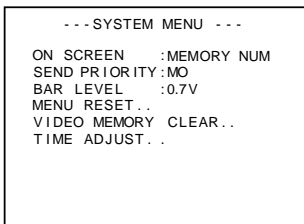

PLAY menu screen

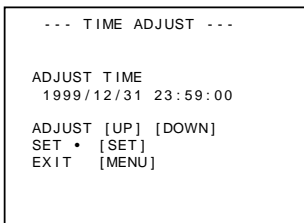

TIME ADJUST screen

3. The year will be displayed in purple to indicate that it can be changed. Press the UP or DOWN button to set the year.
4. When the year setting is completed, press the SET button. The year display will return to white and the month will be displayed in purple to indicate that it can be changed. In the same manner as above, press the UP or DOWN button to set the month.
5. Set the day, hour and minute in the same manner. The seconds display will display 00. The clock will start when the 00 is displayed in purple and the SET button is pressed. Press the SET button when the actual time reaches 00 seconds.

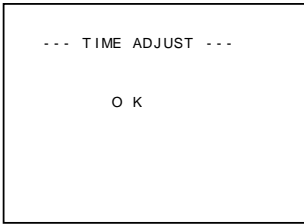

OK display screen

6. OK will be displayed for approximately 3 seconds and the unit will return to the menu screen.

MEMO

When setting the time and date, always set the seconds (00).

Pressing the MENU button before setting the seconds will not change the set values.

Focus adjustment

This unit is not equipped with a back-focus feature. Adjust the back focus using the lens.

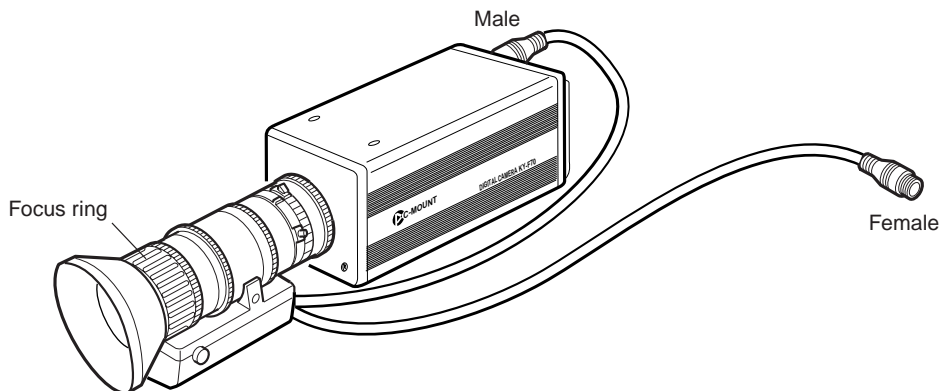

The default setting of the main unit shutter speed is 1/8. When difficult to focus, change the shutter speed to 1/30 using the procedure given below.

Shutter speed

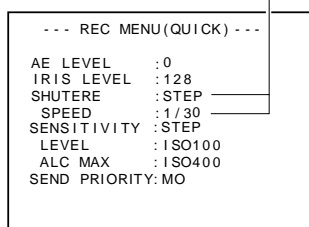

REC mode quick menu screen

1. Press the MODE button to enter the REC mode (REC LED ON). Next, lightly press the MENU button to display the REC mode quick menu screen.
2. Press the DOWN and SET buttons to change SHUTTER to STEP.
3. Press the DOWN button to select SHUTTER SPEED, then press the SET button. 1/8 will be displayed in purple, indicating that it can be changed.
4. Press the UP or DOWN button to change the value to 1/30, then press the SET button. When confirmed, the set value of 1/30 will be displayed in white.

MEMO

At this time, pressing the MENU button without pressing the SET button will not confirm the set value and the unit will return to the setting prior to the change.

5. Press the MENU button to return to the normal screen.

3. Settings and adjustments for recording (continued)

White balance adjustment

Since the color of light (light temperature) changes depending on the light source, readjust the white balance (AUTO WHITE) when the light source of the object changes.

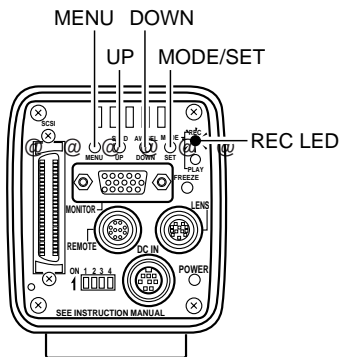

1. Press the MODE button to enter the REC mode (REC LED on), then press and hold the MENU button for at least 2 seconds to display the REC MENU screen. (If the button is pressed for less than 2 seconds, the REC mode quick menu will appear. [▶ Page 47](#))

2. Press the DOWN button, select 2. WHITE BALANCE (the text will be displayed in purple when selected), then press the SET button. The WHITE BALANCE screen will appear.

3. Press the UP or DOWN button to select COLOR TEMP (the text will be displayed in purple when selected), then press the SET button. The set value will be displayed in purple, indicating that it can be changed.

4. Press the UP or DOWN button to select the setting depending on the usage environment.
 3200K: when using low temperature lighting such as a halogen lamp, etc.
 5200K: when using high temperature lighting such as the sun, etc.

Pressing the SET button will register the setting in the main unit memory.

MEMO

Pressing the MENU button without pressing the SET button will not register the set value and the unit will return to the setting prior to the change.

5. Press the UP/DOWN and SET buttons to set WHITE BAL in the WHITE BALANCE screen to AUTO.

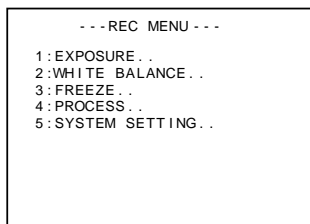

REC MENU screen

Menu item Set value

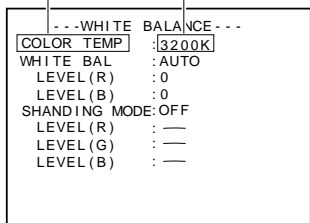

WHITE BALANCE screen

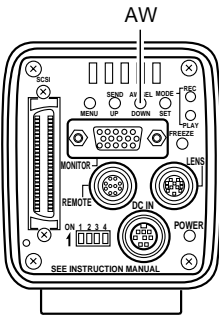

Auto white in operation

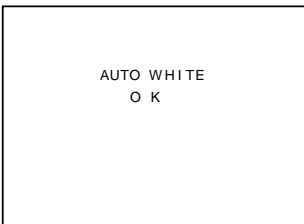

Auto white operation completed

6. After pressing the MENU button twice to return to the normal screen, place a white object with the same lighting conditions as the object to record, then zoom in to display white on the screen.

7. Press the AW (Auto White) button.

- When auto white is in operation, OPERATION will be displayed on the monitor screen.
- When the white balance is successfully set, OK will appear on the screen and the unit will return to the normal screen.

MEMO

When setting the VGA mode to FINE, using the SXGA mode or setting the unit to a slow shutter speed, the white balance operation may take some time before completion.

- **Error display**
When the auto white balance cannot be set, one of the following error messages will appear and the unit will return to the normal screen.

NG: OBJECT (bad object)

Displayed when the object consists of little whiteness or when the color temperature is not correct. Change to a white object and redo the white balance.

ERROR: LOW LIGHT (shortage of light)

Displayed when the lighting is too dark. Brighten the lighting and redo the white balance.

ERROR: OVER LIGHT (excessive light)

- Displayed when the lighting is too bright. Lower the brightness and redo the white balance.
- If the color temperature of the object changes when darkening the lighting, redo the white balance after pressing the AW button on the panel.

3. Settings and adjustments for recording (continued)

White shading adjustment

Even if the white balance is successfully achieved in the center of the screen, there may be times when white balance cannot be achieved at the top and bottom of the screen, resulting in the color of green and magenta becoming discolored. This is due to the characteristic of the lens and the adjustment of this is called the white shading adjustment.

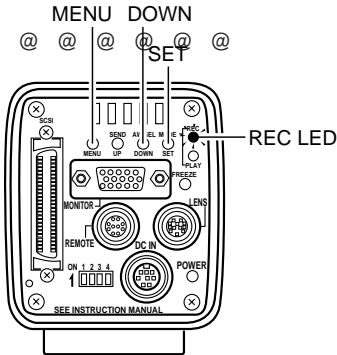

Perform the following after adjusting the white balance.

- 1.** Press the MODE button to enter the REC mode (REC LED on), then press and hold the MENU button for at least 2 seconds to display the REC MENU screen. (If the button is pressed for less than 2 seconds, the REC mode quick menu will appear. [Page 38](#))
- 2.** Press the DOWN button, select 2. WHITE BALANCE (the text will be displayed in purple when selected), then press the SET button. The WHITE BALANCE screen will appear.
- 3.** Press the UP/DOWN and SET buttons to set SHADING MODE in the WHITE BALANCE screen to ADJUST. The set value will be displayed in purple, indicating that it can be adjusted.

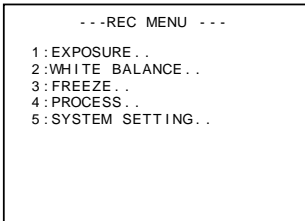

REC MENU screen

```
--- WHITE BALANCE ---  
COLOR TEMP  :3200K  
WHITE BAL   :AUTO  
LEVEL (R)   :0  
LEVEL (B)   :0  
SHANDING MODE:ADJUST  
LEVEL (R)   :0  
LEVEL (G)   :0  
LEVEL (B)   :0
```

WHITE BALANCE screen

4. While watching the monitor screen, change LEVEL (R), LEVEL (G) and LEEL (B) using the UP and DOWN buttons.

For each item, the color at the bottom weakens and the color at the top strengthens as the number becomes larger

<Variable range: -128 ~ 127>

5. When the adjustments of all channels (R, G and B channels) are completed, redo the white balance adjustment.

4. Basic operations

Recording images to the main unit memory

The main unit is capable of storing 5 images in the VGA mode and 4 images in the SXGA mode to the main unit memory.

Exceeding the maximum number of images stored will replace the oldest image with the latest.

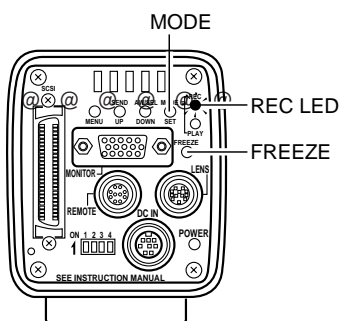

FREEZE display

1. Press the MODE button to enter the REC mode.
The REC LED will light.

MEMO

The unit will automatically enter the REC mode when the power is turned on.

2. Press the FREEZE button.
Images outputted through the MONITOR terminal will become a still image and stored in the main unit memory. In addition, the REC LED will flash.
At this time, FREEZE will appear in the screen. To disable the message from appearing, set FRZ DISPLAY to OFF (Page 57).

MEMO

The character display contents of the monitor screen can be changed by selecting ON SCREEN in the SYSTEM SETTING screen. (Page 57)

3. Cancel FREEZE
Press the FREEZE button once more to cancel the still image.

MEMO

It is possible to set the unit so that the still image is automatically cancelled after 5 seconds. Set CANCEL in the FREEZE screen to AUTO. (Page 53)

4. Output the image to an MO drive or printer, as necessary.
(Pages 36 and 37)

CAUTION

Images stored in memory will be deleted when the power is turned off.

Playing back images from the memory

It is possible to play back images stored in the main unit memory. When in the VGA mode, images will be displayed in 640×480 pixels, regardless of whether in the FINE or DRAFT mode.

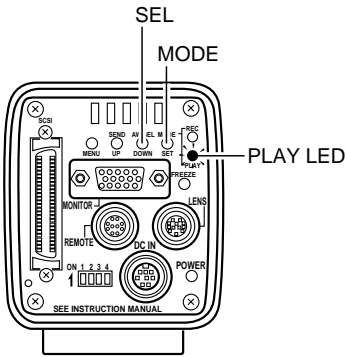

1. Press the MODE button to enter the PLAY mode.
The PLAY LED will light and the latest image stored will be displayed on the monitor.
 - At this time, the memory image no. will be displayed at the bottom right of the screen.

MEMO

The character display contents of the monitor screen can be changed by selecting ON SCREEN in the SYSTEM SETTING screen. ([Page 57](#))

2. Pressing the SEL button each time will switch the from latest image to the others recorded previously in order.
3. Images for playback can also be outputted to an MO drive or printer ([pages 36 and 37](#)).

Returning to the REC mode

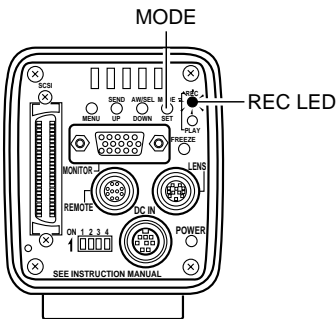

To return to the REC mode when displaying images, press the MODE button to light the REC LED.

4. Basic operations (continued)

Saving images from the memory to an MO disk

It is possible to save images stored in the main unit memory to an MO drive connected via the SCSI terminal when in the FREEZE or PLAY mode.

(To output to an MO drive connected to a PC, see Page 64 7. Connecting to a PC)

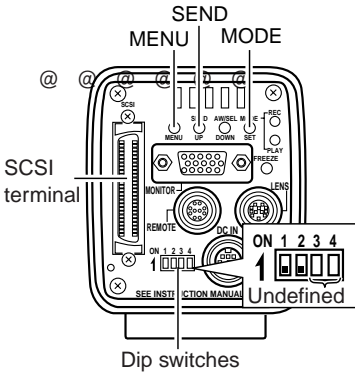

■ Set to either the FREEZE or PLAY mode.

1. Check to make sure that dip switches 1 and 2 are set to OFF as shown in the diagram on the left.
2. Press the SEND button. WRITE TO MO OK? message will appear on the monitor connected to the MONITOR terminal.
3. To write to the MO, press the MODE button (to cancel, press the MENU button). While in operation, WRITE TO MO OPERATION will appear for approximately 3 seconds.

Output confirmation

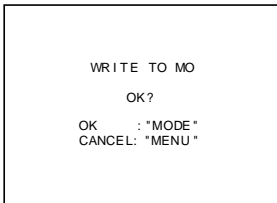

Output in operation

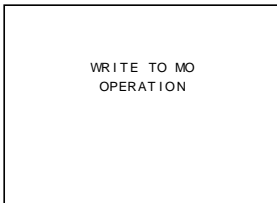

Output completed

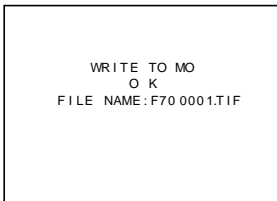

4. When data is successfully written to the MO, WRITE TO MO OK FILE NAME: F70□□□.TIF will appear for approximately 3 seconds. (each □ indicates a number)
5. When data is not successfully written to the MO, one of the following error messages will appear for approximately 3 seconds.
 - ERROR : SCSI (check the cable)
 - ERROR : WRITE (write error)
 - ERROR : FORMAT (format the disk)
 - ERROR : DISK (bad MO disk)
 - ERROR : DIRECTRY (directory error)
 - ERROR : READ (read error)
 - ERROR : MO (Other MO disk error)

Outputting images from the memory to a printer

Use a printer with an SCSI input terminal.

It is possible to directly output images stored in the main unit memory to a printer connected via the SCSI terminal when in the FREEZE or PLAY mode.

(To output to a printer connected to a PC, see Page 64 7. Connecting to a PC)

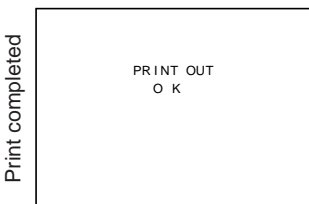
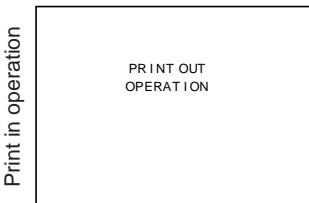
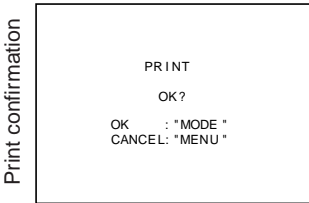

■ Set to either the FREEZE or PLAY mode.

1. Check to make sure that dip switches 1 and 2 are set to OFF as shown in the diagram on the left ( page 36).
2. Press the SEND button. PRINT OK? message will appear on the monitor connected to the MONITOR terminal.
3. To print, press the MODE button (to cancel, press the MENU button). While in data is being written, PRINT OUT OPERATION will appear for approximately 3 seconds.
4. When data is successfully outputted to the printer, PRINT OUT will appear for approximately 3 seconds.
5. When data is not successfully outputted to the printer, one of the following error messages will appear for approximately 3 seconds.
ERROR : SCSI (check the cable)
ERROR : PRINTER (printer error)

MEMO

- Set the SCSI ID of the MO drive or printer to other than 7.
- IF both MO drive and printer are connected to the SCSI terminal, select which source to output to by selecting SEND PRIORITY in the SYSTEM SETTING screen ( Page 57; default setting: MO).
- Do not connect devices other than printers and MO drives to the SCSI terminal since correct output will not be achieved. In addition, only one output device may be connected per one unit.

4. Basic operations (continued)

Clearing images from the memory

This function will clear all images stored in the main unit memory.

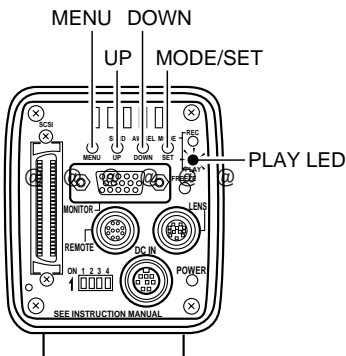

1. Press the MODE button to enter the PLAY mode (PLAY LED on), then press the MENU button to display the MENU screen.

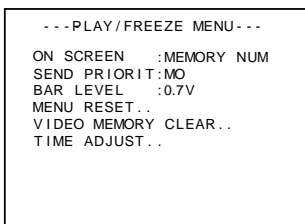

PLAY mode menu screen

2. Press the DOWN button, select VIDEO MEMORY CLEAR (displayed in purple when selected), then press the SET button to display the VIDEO MEMORY CLEAR screen.

(The same screen can also be displayed by selecting 5. SYSTEM SETTING in the REC menu then selecting VIDEO MEMORY CLEAR.)

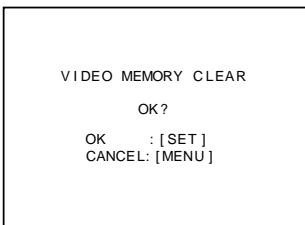

VIDEO MEMORY CLEAR screen

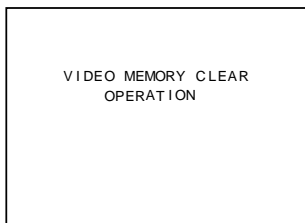

Clearing memory

3. Press the SET button to clear all images stored in the internal memory. During operation, VIDEO MEMORY CLEAR OPERATION will be displayed.

MEMO

To cancel, press the MENU button to return to the MENU screen without clearing the images.

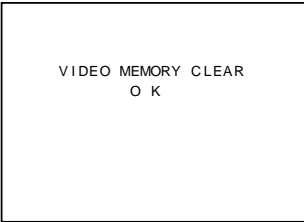

VIDEO MEMORY CLEAR
O K

Memory cleared

4. When completed, VIDEO MEMORY CLEAR OK will appear for approximately 3 seconds and the unit will return to the MENU screen.

MEMO

After clearing the entire memory in the PLAY mode, the unit will automatically enter the REC mode since no images will be available for playback.

5. Press the MENU button once more to return to the normal screen.

5. Various recording methods

Recording a PC monitor

Horizontal line noise will appear on the screen when attempting to record images on a PC monitor or display. To clear this noise, the main unit shutter speed must be adjusted with scan speed of the monitor.



PC monitor

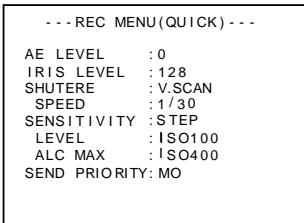

REC quick menu screen

1. Press the MODE button to enter the REC mode (REC LED on), then lightly press the MENU button to display the REC quick menu screen.
2. Press the DOWN button to select SHUTTER, then press SET (SHUTTER will be displayed in purple).
3. Use the DOWN button to change the set value to V.SCAN, then press the SET button (SHUTTER will return to white).
4. Next, press the DOWN button to select SHUTTER SPEED, then press the SET button.
5. Press either UP or DOWN to change the shutter speed.
When a black bar can be seen on the screen:
decrease the shutter speed by pressing the DOWN button.
When a white bar can be seen on the screen:
increase the shutter speed by pressing the UP button.
6. Press the SET button when the bar is at its minimum.

MEMO

At this time, pressing the MENU button will return the unit to its previous settings without confirming the changes.

7. Press the MENU button to return to the normal screen.

MEMO

- The vertical scan frequency differs depending on the PC type and the bar may not be completely cleared away. The frequency may also change depending on the software used.

Outputting negative images

It is possible to change the video signal outputted through the MONITOR terminal of this unit as negative video.

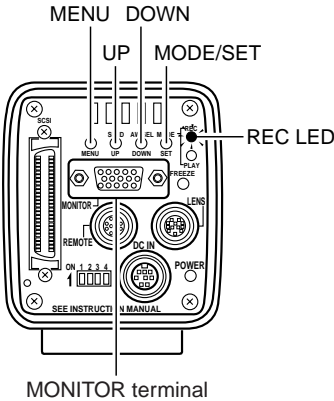

- 1.** Press the MODE button to enter the REC mode (REC LED on), then press the MENU button to display the REC MENU screen.
- 2.** Use the DOWN button to select 5. SYSTEM SETTING (displayed in purple when selected), then press the SET button. The SYSTEM SETTING screen will appear.
- 3.** Press the DOWN button to select NEGA (NEGA will be displayed in purple when selected), then press the SET button. The set value will be displayed in purple, indicating that it can be changed.
- 4.** Press the DOWN button to set the value to ON. The output video will be negative video.

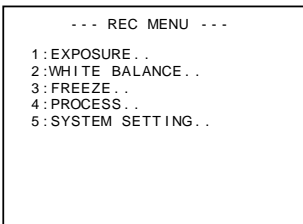

REC MENU screen

Menu item	Set value
--- SYSTEM SETTING ---	
ON SCREEN	: OFF
FRZ DISPLAY	: ON
SEND PRIORITY	: MO
MONITOR	: FINE
BAR LEVEL	: 0.7V
NEGA	: ON
MENU RESET	..
VIDEO MEMORY CLEAR	..
TIME ADJUST	

SYSTEM SETTING screen

Synchronizing flash and FREEZE

To activate the flash when inputting FREEZE, use the REMOTE terminal.

The REMOTE terminal located in the rear is also used to freeze an image using an external device other than the FREEZE button on the rear of the main unit.

Explanation of terminals ( page 12)

- In response to FREEZE input, KY-F70 outputs a flash signal for the CCD accumulation period of the next frame.
- The time required for flash output from FREEZE input depends on the timing of the FREEZE input and shutter speed. In addition, the pulse length of the flash output differs depending on the shutter speed.
- The slow shutter will also be used when the unit is in the SXGA mode or FINE mode of the VGA mode with shutter speed of 1/7.5 sec. or slower, or when in the DRAFT mode of the VGA mode with shutter speed of 1/30 sec. or slower.
- Since the above diagram is the timing chart when in the SXGA mode, CCD OUT and ANALOG OUT are synchronous. However, the timing of ANALOG OUT will be asynchronous with CCD OUT when in the VGA mode and there will also be no WEN output.
- When in the VGA mode, FREEZE input is ignored until the FREEZE screen is completely displayed on the monitor.
- Even for the SXGA mode, FREEZE input for continuous frames are not recognized and FREEZE input interval for high speed shutters also require a minimum of 2 frames (270ms).
- When the FREEZE cancel mode is set to MANUAL, the FREEZE input for FREEZE cancellation will not output a FLASH signal or WEN.

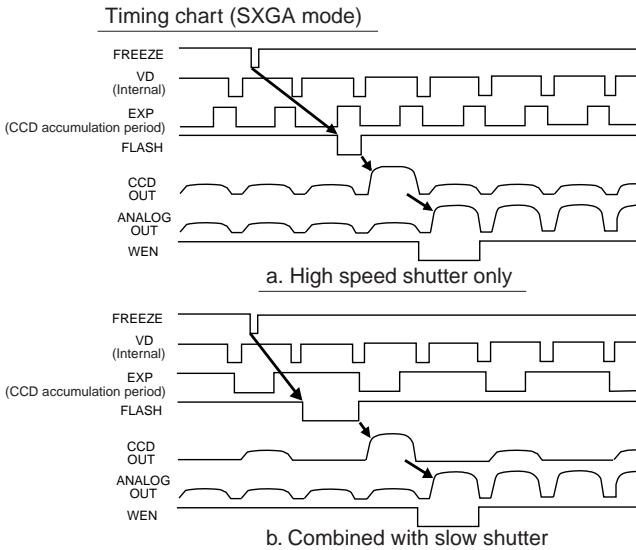

About ALC and EEI operations

ALC refers to Automatic Level Control and EEI refers to shutter iris control.

The Automatic Level Control (ALC) operates under dark lighting and the electronic shutter (EEI) operates under bright lighting. Furthermore, setting the IRIS mode to AUTO will synchronize sensitivity, iris and electronic shutter and appropriate signal level can be acquired automatically at all times.

The ALC mode increases sensitivity from 0dB (ISO100) to +12dB (ISO400) under dark lighting and the EEI mode automatically adjusts the electronic shutter within the range of 1/7.5 to 1/255.1 (calculated value) when in FINE under bright lighting (1/30.2 to 1/255.1 for DRAFT). In other words, the signal level is adjusted in the range of 2 graduations of the aperture under dark lighting and 5 graduations when in FINE under bright lighting. When the iris is set to manual, the sensitivity and electronic shutter are continuously changed without changing the iris setting. This feature holds the advantage of being able to record under changing light conditions without changing the depth of field.

Operational range

Light 1×

	16	32	62.5	125	-	-	-	250	500	1000	2000	4000	8000	16000	32000
--	----	----	------	-----	---	---	---	-----	-----	------	------	------	------	-------	-------

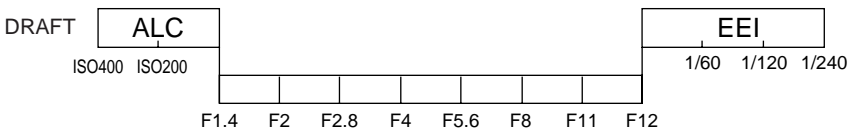
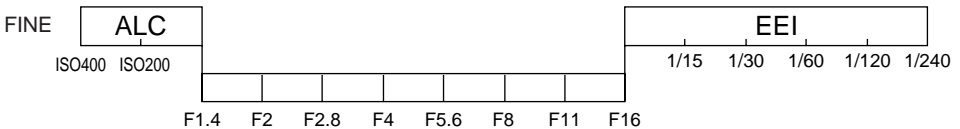

6. Menu screen settings

Menu screen flow

There are 3 types of menu screens: PLAY menu screen, REC quick menu screen and REC normal menu screen.

MEMO

- Pressing the MENU button while in any of the menu screens will return the unit to the previous screen.
- Press the MENU button for more than 2 seconds while in the REC mode will display not the REC quick menu but the REC normal menu screen.
- The MENU RESET screen, MEMORY CLEAR screen, TIME ADJUST screen can all be accessed from the PLAY menu screen of REC normal menu screen.

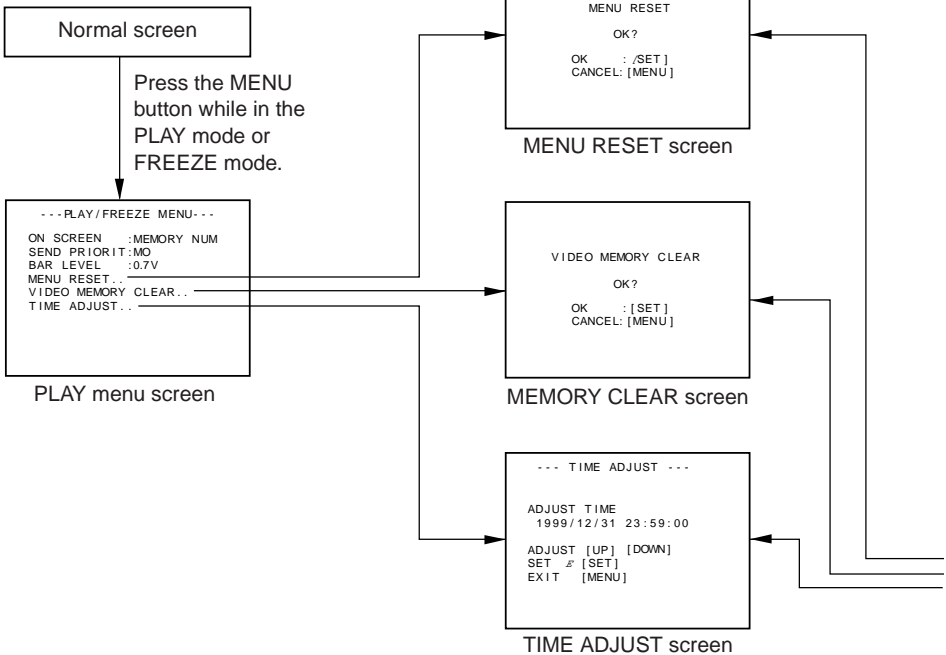
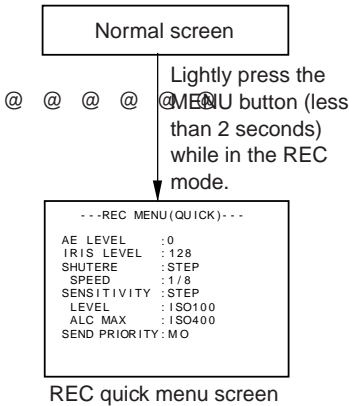

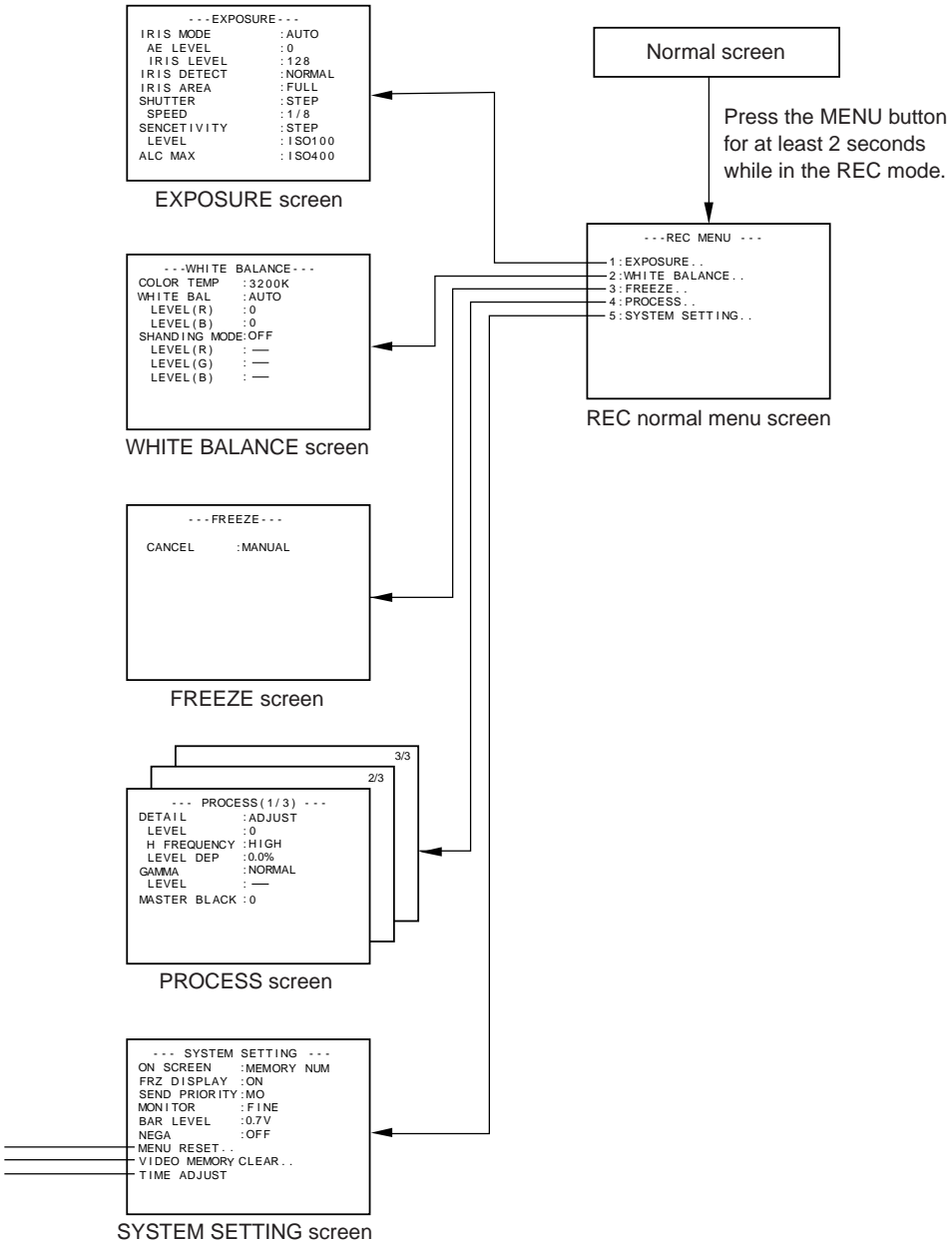

6. Menu screen settings (continued)

Setting procedure

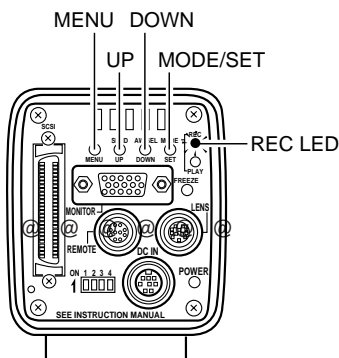

REC normal menu screen

1. Press the MODE button to enter the REC mode (REC LED on), then press and hold the MENU for at least 2 seconds to display the REC normal menu screen. (If the MENU button is not pressed long enough, the REC mode quick menu will appear. In this case, press the MENU button to return to the normal screen, then press and hold the MENU button for at least 2 seconds.)

2. Press the UP or DOWN button to select a menu item (the menu item will be displayed in purple when selected), then press the SET button to display the submenu screen.

3. In the submenu screen, press the UP or DOWN button in the same manner as above to select a submenu item, then press the SET button. The set value will be displayed in purple, indicating that it can be changed.

4. Use the UP and DOWN buttons to change to set value, then press the SET button to confirm (the set value will return to white). Pressing the UP or DOWN button increments the set value in unit of 10. Use this feature when making large changes in value.

MEMO

Pressing the MENU button at this time will return the setting to the previous value without making changes.

5. Press the MENU button to return to the menu screen.

Menu item

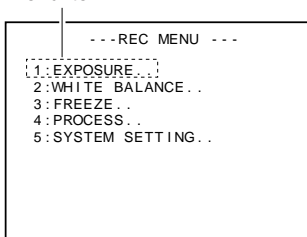

REC normal menu screen

Menu item Set value

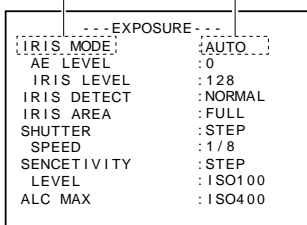

Submenu screen (example)
EXPOSURE menu

---PLAY/FREEZE MENU---

ON SCREEN : MEMORY NUM
SEND PRIORITY: MO
BAR LEVEL : 0.7V
MENU RESET...
VIDEO MEMORY CLEAR...
TIME ADJUST..

PLAY menu screen

PLAY menu screen

1. Enter the PLAY or FREEZE mode, then press the MENU button to display the PLAY menu screen.
- 2~5. Follow the steps described in the REC normal screen menu.

---REC MENU(QUICK)---

AE LEVEL : 0
IRIS LEVEL : 128
SHUTTER : STEP
LEVEL : 1/8
SENSITIVITY : STEP
SPEED : ISO100
ALC MAX : ISO400

REC quick menu screen

REC quick menu screen

1. Press the MODE button to enter the REC mode (RED LED on), then lightly press the MENU button to display the REC quick menu screen.
(If the MENU button is pressed for more than 2 seconds, the REC normal menu will appear. In this case, press the MENU button to return to the normal screen, then press the MENU lightly.)
- 2~5. Follow the steps described in the REC normal screen menu.

About the submenu screens of the normal REC menu

- 1 : EXPOSURE: Used for video level related settings such as iris, shutter, sensitivity, etc. (☞ page 48)
- 2 : WHITE BALANCE: Used to make settings for color temperature, white balance, shading compensation, etc. (☞ page 51)
- 3 : FREEZE: Used to set the cancel method when using the FREEZE function. (☞ page 53)
- 4 : PROCESS (1/3): Used to set the detail compensation, gamma and master black. (☞ page 53)
 - (2/3): Used to set the flare compensation and ABL.
 - (3/3): Used to set the color matrix.
- 5 : SYSTEM SETTING: Used when executing screen display, VGA mode switch and initialization. (☞ page 57)

6. Menu screen settings (continued)

EXPOSURE screen

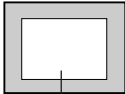
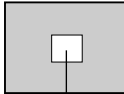
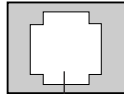
Menu item	Function/variable range	Default value
IRIS MODE	Set depending on the used lens AUTO: when using an auto-iris lens MANUAL: when using a manual iris lens or no lens	ATUO
AE LEVEL @ @ @ @ @	Used to adjust the video level when using auto iris, ALC and EEI. Raise the level: increase the number Lower the level: decrease the number [Variable range: -128 ~ 127]	0
IRIS LEVEL	Used to set the iris level when the IRIS MODE is set to MANUAL. Open iris: increase the number Close iris: decrease the number [Variable range: 0 ~ 255]	128
IRIS DETECT	Used to change the set value of the detection level during auto iris. NORMAL: normal position PEAK: detects the peak brightness level for better view of highly bright objects. AVG: detects the average brightness for better view of objects.	NORMAL
IRIS AREA	Used to set the detection area during auto iris. Set according to the usage condition. <div style="display: flex; justify-content: space-around; text-align: center;"> <div> <p>FULL</p>  <p>Detection area</p> </div> <div> <p>SQUARE</p>  <p>Detection area</p> </div> <div> <p>SPOT</p>  <p>Detection area</p> </div> <div> <p>CIRCLE</p>  <p>Detection area</p> </div> </div> <p>MEMO When selecting the detection area, the area is displayed on the screen.</p>	FULL

EXPOSURE screen (continued)

Menu item	Function/variable range	Default value
SHUTTER	<p>Used to set the shutter mode.</p> <p>STEP: the shutter speed can be changed using the SPEED submenu item.</p> <p>V.SCAN: used to clear the horizontal line noise when recording a PC monitor by adjusting to the scan speed of the monitor.</p> <p>The shutter can be changed in detail using the LEVEL submenu item. ( Page 42 Recording a PC monitor)</p> <p>EEl: Used to automatically change the shutter speed depending on the object brightness. (max: 1/1920)</p> <p>OFF: <ul style="list-style-type: none"> • 1/30 when VGA is set to the DRAFT mode • 1/7.5 when VGA is set to the FINE mode • 1/7.5 when in the SXGA mode </p>	STEP
SPEED	<p>The shutter speed can be changed when the shutter is set to STEP or V.SCAN.</p> <p>[STEP variable range: 1/1, 1/2, 1/4, 1/8, 1/15, 1/30, 1/60, 1/125, 1/250, 1/500, 1/1000, 1/2000]</p> <p>[V.SCAN variable range: 1/30, ~ 1/5906. 8]</p> <div style="border: 1px solid black; padding: 10px; margin-top: 10px;"> <p>MEMO</p> <ul style="list-style-type: none"> • In areas which the power supply frequency is 50Hz, setting the unit to 1/100 can reduce flickering when recording under fluorescent lighting. • There may be shortage of light when increasing the shutter speed. In this case, adjust the iris or sensitivity. Special attention is required for the picture quality when raising the sensitivity since images may become distorted. </div>	STEP: 1/8 V.SCAN: 1/30

6. Menu screen settings (continued)

EXPOSURE screen (continued)

Menu item	Function/variable range	Default value
SENSITIVITY @ @ @ @ @ @	Used to set the sensitivity mode. STEP: the sensitivity can be changed using the LEVEL submenu item. ALS: the sensitivity is automatically changed by the brightness. Maximum sensitivity is set in the next ALC MAX menu item. V.SENS: the sensitivity can be set in detail using the LEVEL submenu item.	STEP
LEVEL	The sensitivity can be changed when the sensitivity mode is set to STEP or V.SENS. [STEP variable range: ISO100, ISO200, ISO400] [V.SENS variable range: ISO100 ~ ISO400]	STEP: ISO100 V. SENS: ISO100
ALC MAX	This can be set when the sensitivity mode is set to ALC. Used to set the maximum sensitivity of ALC, which automatically switches the sensitivity depending on the brightness. [Variable range: ISO200, ISO400]	ISO400

WHITE BALANCE screen

Menu item	Function/variable range	Default value
COLOR TEMP	Used to set the basic color temperature of the white balance. 3200K: for use under low color temperature such as halogen lamps, etc. 5200K: for use under high color temperature such as the sunlight, etc.	3200K
WHITE BAL	Used to set the white balance mode. PRESET: the white balance is locked to the COLOR TEMP setting. (3200K:141/5200K:101) AUTO: Used when adjusting the white balance. (☞ Page 30 White balance adjustment) Fine adjustment can be made for the white balanced using LEVEL (R) and LEVEL (B). MANUAL: the white balance can be changed using LEVEL (R) and LEVEL (B).	AUTO
LEVEL (R)	The color red of the white balance can be adjusted when WHITE BALANCE is set to AUTO or MANUAL. Increase the number: stronger red on the screen Decrease the number: weaker red on the screen [Variable range during AUTO: -32 ~ 31] [Variable range during MANUAL: 0 ~ 255]	AUTO : 0 MANUAL : 128
LEVEL (B)	The color blue of the white balance can be adjusted when WHITE BALANCE is set to AUTO or MANUAL. Increase the number: stronger blue on the screen Decrease the number: weaker blue on the screen [Variable range during AUTO: -32 ~ 31] [Variable range during MANUAL: 0 ~ 255]	AUTO : 0 MANUAL : 128

FREEZE screen

Menu item	Function/variable range	Default value
CANCEL	Used to set the cancellation method of FREEZE. MANUAL: freeze is cancelled by pressing the FREEZE button. AUTO: freeze is automatically cancelled after 5 seconds.	MANUAL

PROCESS (1/3) screen

Menu item	Function/variable range	Default value
DETAIL	Used to set whether to emphasize details. ADJUST: changes the detail emphasis OFF: no detail emphasis	ADJUST
LEVEL	The emphasis level of the detail is adjusted when DETAIL is set to ADJUST. Sharpen the detail: increase the number Soften the detail: decrease the number [Variable range: -7 ~ 7]	0
H FREQUENCY	Used to change the frequency of the detail emphasis when DETAIL is set to ADJUST. HIGH: increases the frequency of the detail emphasis. Used when recording objects with detailed patterns. LOW: decreases the frequency of the detail emphasis. Used when recording objects with large patterns.	HIGH
LEVEL DEP	This can be set when DETAIL is set to ADJUST. Depending on the detail emphasis, noise may increase in black areas. To reduce the amount of noise in black areas, set the video level in this menu which does not emphasize the detail. [Variable range when ON: 0.0% ~ 28.5% (0.5 steps)]	0.0%

6. Menu screen settings (continued)

PROCESS (1/3) screen (continued)

Menu item	Function/variable range	Default value
GAMMA @ @ @ @ @	Used to set whether the gamma curve to determine the reproduction of black is to be set using the standard value or available for change. NORMAL: the gamma curve is set using the standard value (0.45) @ADJUST: set when changing the gamma curve	NORMAL
LEVEL	The gamma curve can be adjusted only when GAMMA is set to ADJUST. Increase the number: improves the reproduction of black. However, the reproduction quality of bright areas becomes lower. Decrease the number: improves the reproduction of bright areas. However, the reproduction quality of black becomes lower. [Variable range: 0.35 ~ 1.00 (21 steps)]	0.45
MASTER BLACK	Used to adjust the pedestal level (master black), which is the standard black during lens cap. To view black areas, increase the pedestal level to brighten the entire screen. Increase the pedestal level: increase the number Decrease the pedestal level: decrease the number [Variable range: -99 ~ 99]	0

PROCESS (2/3) screen

Menu item	Function/variable range	Default value
FLARE (R)	<p>Rch compensation of the black level when flaring effect occurs and the entire screen becomes washed out from the light entering the lens reflecting diffusely. Perform this function along with FLARE (B).</p> <p>Stronger red: increase the number Weaker red: decrease the number [Variable range: -128 ~ 127]</p>	0
FLARE (B)	<p>Bch compensation of the black level when flaring effect occurs and the entire screen becomes washed out from the light entering the lens reflecting diffusely. Perform this function along with FLARE (R).</p> <p>Stronger blue: increase the number Weaker blue: decrease the number [Variable range: -128 ~ 127]</p>	0
ABL	<p>Used to set whether to automatically adjust the black level of the video when recording. Adjust when the black level of the video during recording fluctuates.</p> <p>NORMAL: executes ABL (Auto Black Level) adjustment using a fixed value. ADJUST: the compensation of the ABL adjustment can be changed using the LEVEL submenu item below.</p>	NORMAL
LEVEL	<p>The black level can be adjusted only when ABL is set to ADJUST.</p> <p>Decrease the black level (higher compensation): increase the number Increase the black level (lower compensation): decrease the number [Variable range: -25 ~ 25]</p>	0

6. Menu screen settings (continued)

PROCESS (2/3) screen (continued)



Menu item	Function/variable range	Default value
COLOR MATRIX	Used to set whether to change the color matrix or use the standard value. OFF: the standard value of the color matrix is used. ADJUST: the color matrix becomes available for change. The following adjustments can only be made with this setting.	OFF
@ @ @ @ @ @	@	
R-G	Used to adjust the R-G signal (0 ~ 25%) [Variable range: 0 ~ 31]	12
R-B	Used to adjust the R-B signal (0 ~ 25%) [Variable range: 0 ~ 31]	12
G-R (+)	Used to adjust the G-R (+) signal (0 ~ 25%) [Variable range: 0 ~ 31]	8
G-R (-)	Used to adjust the G-R (-) signal (0 ~ 25%) [Variable range: 0 ~ 31]	3
G-B (+)	Used to adjust the G-B (+) signal (0 ~ 25%) [Variable range: 0 ~ 31]	8
G-B (-)	Used to adjust the G-B (-) signal (0 ~ 25%) [Variable range: 0 ~ 31]	3
B-R	Used to adjust the B-R signal (0 ~ 25%) [Variable range: 0 ~ 31]	2
B-G (+)	Used to adjust the B-G (+) signal (0 ~ 25%) [Variable range: 0 ~ 31]	0
B-G (-)	Used to adjust the B-G (-) signal (0 ~ 25%) [Variable range: 0 ~ 31]	17

SYSTEM SETTING screen



Menu item	Function/variable range	Default value
ON SCREEN	<p>Used to set the text to display in the video signal outputted to the MONITOR terminal.</p> <p>ALC EEI: displays ALC and EEI status during the REC mode.</p> <p>MEMORY NUM: displays the memory image number during the PLAY mode.</p> <p>BOTH: displays both sensitivity during REC mode and memory image number during PLAY mode.</p> <p>OFF: no text is displayed for either REC mode or PLAY mode.</p>	MEMORY NUM
FRZ DISPLAY	<p>Used to set whether to display FREEZE on the screen when in operation.</p> <p>ON: displays FREEZE on the screen</p> <p>OFF: no display</p>	ON
SEND PRIORITY	<p>Used to set which device has output priority when both printer and MO drive are connected.</p> <p>PRINTER: output priority is given to the printer.</p> <p>MO: output priority is given to the MO drive.</p>	MO
MONITOR	<p>Used to set the video resolution outputted when in the VGA mode.</p> <p>FINE: 640 × 480 pixels (however, video is outputted in 7.5 frames per second)</p> <p>DRAFT: 640 × 240 pixels (video is outputted in 30 frames per second)</p> <div style="border: 1px solid black; padding: 5px; margin-top: 10px;"> <p>MEMO</p> <p>This menu item cannot be selected when the unit is set the SXGA mode using the dip switches located on the rear. (----- is displayed)</p> </div>	FINE

6. Menu screen settings (continued)

SYSTEM SETTING screen (continued)

Menu item	Function/variable range	Default value
BAR LEVEL	Used to set the level of the color bar signal outputted from the MONITOR terminal of this unit. 0.7V: outputs 0.7V color bar signals 0.58V: outputs 0.58V color bar signals	0.7V
MEGA @ @ @	It is possible to change the outputted signals to the MONITOR terminal to negative signals. ON: outputs negative signals OFF: does not output negative signals	OFF
MENU RESET	Initializes all menu switch settings other than the time and date. Resetting settings ( page 62)	
VIDEO MEMORY CLEAR	Clears all images stored in the main unit memory. Clearing all images from the memory ( page 38)	
TIME ADJUST	Calls the time and date setting screen. Setting the time and date ( page 26)	

Menu screen of the PLAY mode

Menu item	Function/variable range	Default value
ON SCREEN	Used to set the text to display in the video signal outputted to the MONITOR terminal. ALC EEI: displays ALC and EEI status during the REC mode. MEMORY NUM: displays the memory image number during the PLAY mode. BOTH: displays both sensitivity during REC mode and memory image number during PLAY mode. OFF: no text is displayed for either REC mode or PLAY mode.	MEMORY NUM
SEND PRIORITY	Used to set which device has output priority when both printer and MO drive are connected. PRINTER: output priority is given to the printer. MO: output priority is given to the MO drive.	MO
BAR LEVEL	Used to set the level of the color bar signal outputted from the MONITOR terminal of this unit. 0.7V: outputs 0.7V color bar signals 0.58V: outputs 0.58V color bar signals	0.7V
MENU RESET	Initializes all menu switch settings other than the time and date. Resetting settings ( page 62)	
VIDEO ME.MORY CLEAR	Clears all images stored in the main unit memory. Clearing all images from the memory ( page 38)	
TIME ADJUST	Calls the time and date setting screen. Setting the time and date ( page 26)	

6. Menu screen settings (continued)

REC mode quick menu screen

Menu item	Function/variable range	Default value
AE LEVEL @ @ @ @ @ @	Used to adjust the video level when using auto iris, ALC and EEI. Raise the level: increase the number Lower the level: decrease the number [Variable range: -128 ~ 127]	0
IRIS LEVEL	Used to set the iris level when the IRIS MODE is set to MANUAL. Open iris: increase the number Close iris: decrease the number [Variable range: 0 ~ 255]	128
SHUTTER	Used to set the shutter mode. STEP: the shutter speed can be changed using the SPEED submenu item. V.SCAN: used to clear the horizontal line noise when recording a PC monitor by adjusting to the scan speed of the monitor. The shutter can be changed in detail using the LEVEL submenu item. (Recording a PC monitor ( page 42)) EEI: Used to automatically change the shutter speed depending on the object brightness. (max: 1/255.1) OFF: <ul style="list-style-type: none"> • 1/30 when VGA is set to the DRAFT mode • 1/7.5 when VGA is set to the FINE mode • 1/7.5 when in the SXGA mode 	STEP
SPEED	The shutter speed can be changed when the shutter is set to STEP or V.SCAN. [STEP variable range: 1/1, 1/2, 1/4, 1/8, 1/15, 1/30, 1/60, 1/125, 1/250, 1/500, 1/1000, 1/2000] [V.SCAN variable range: 1/30, ~ 1/5906. 8]	STEP : 1/8 V. SCAN : 1/30

Menu item	Function/variable range	Default value
SPEED	<p>MEMO</p> <ul style="list-style-type: none"> • In areas which the power supply frequency is 50Hz, setting the unit to 1/100 can reduce flickering when recording under florescent lighting. • There may be shortage of light when increasing the shutter speed. In this case, adjust the iris or sensitivity. Special attention is required for the picture quality when raising the sensitivity since images may become distorted. 	
SENSITIVITY	<p>Used to set the sensitivity mode.</p> <p>STEP: the sensitivity can be changed using the LEVEL submenu item.</p> <p>ALS: the sensitivity si automatically changed by the brightness. Maximum sensitivity is set in the next ALC MAX menu item.</p> <p>V.SENS: the sensitivity can be set in detail using the LEVEL submenu item.</p>	STEP
LEVEL	<p>The sensitivity can be changed when the sensitivity mode is set to STEP or V.SENS.</p> <p>[STEP variable range: ISO100, ISO200, ISO400] [V.SENS variable range: ISO100 ~ ISO400]</p>	<p>STEP: ISO100</p> <p>V.SENS: ISO100</p>
ALC MAX	<p>This can be set when the sensitivity mode is set to ALC. Used to set the maximum sensitivity of ALC, which automatically switches the sensitivity depending on the brightness.</p> <p>[Variable range: ISO200, ISO400]</p>	ISO400

6. Menu screen settings (continued)

Resetting settings

This function is used to initialize all settings other than the time and date.

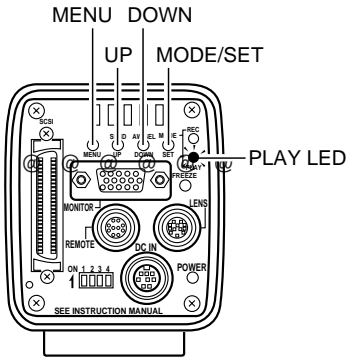

1. Press the MODE button to enter the PLAY mode (PLAY LED on), then press the MENU button to display the MENU screen.

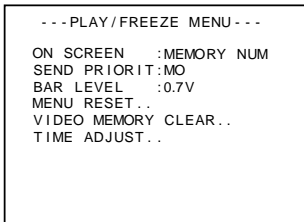

PLAY menu screen

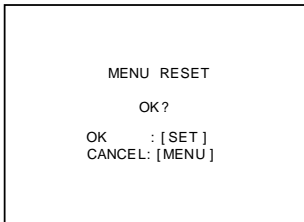

MENU RESET screen

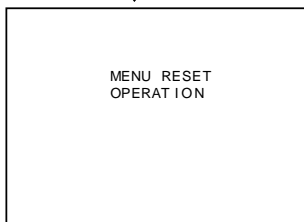

Resetting

2. Press the DOWN button to select MENU RESET (displayed in purple when selected), then press the SET button.
The MENU RESET screen will appear.
(The MENU RESET screen can also be displayed by selecting 5. SYSTEM SETTING in the REC mode, then selecting MENU RESET.)
3. Press the SET button to initialize all settings other than the values set in the TIME ADJUST screen.
At this time, MENU RESET OPERATION message will appear.

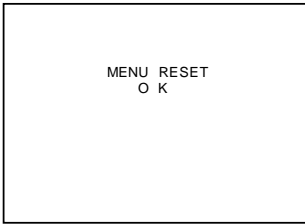

Reset completed

- 4.** When all values are reset to their default settings, MENU RESET OK message will appear for 3 seconds, then the unit will return to the MENU screen.
- 5.** Press the MENU once more to return to the normal screen.

7. Connecting to a PC

Compatible systems 1

With SCSI connection, still images of the main unit can be exported to a PC while checking the recorded images on a VGA monitor.

- The main unit can be controlled from the PC. For this system, the PC is the host (initiator) and the main unit (digital camera) is the target.
- Images exported to a PC can be processed using the Photoshop application software.

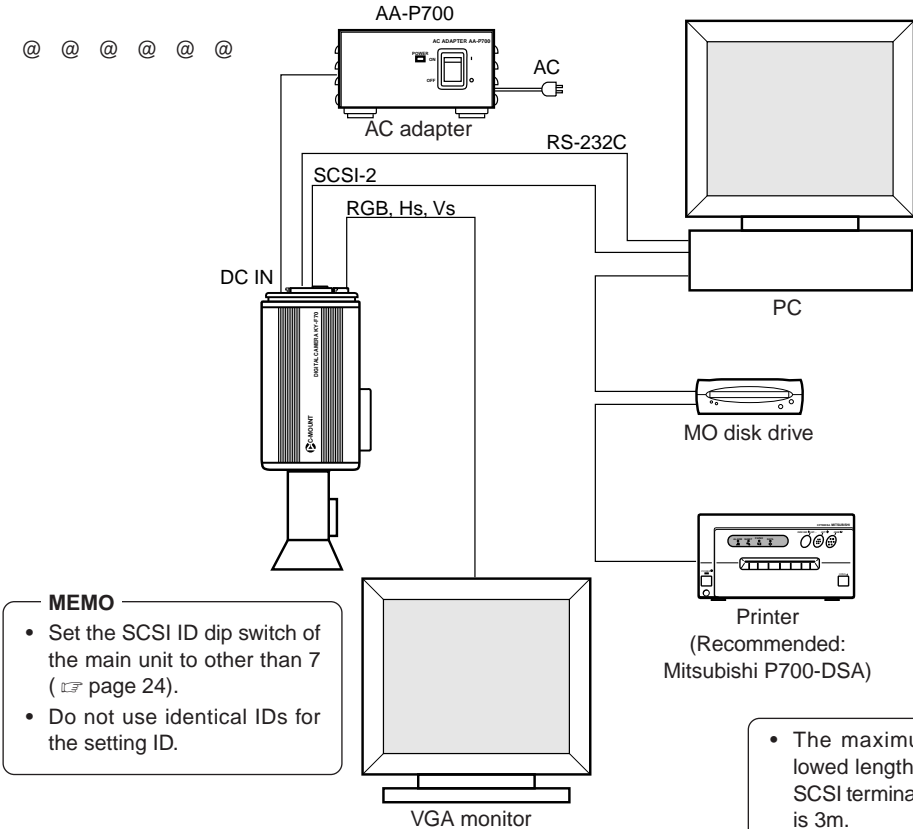

MEMO

- Set the SCSI ID dip switch of the main unit to other than 7 (page 24).
- Do not use identical IDs for the setting ID.

- The maximum allowed length of the SCSI terminal cable is 3m.

* For this system, the attached camera remote control software and the SCSI capture plug-in software must be installed to the PC. For details, see the attached instructions of the software.

■ Camera remote control software

- GUI control
- RS-232C
- SCSI control compatible

■ SCSI capture plug-in software

- Photoshop compatible
- Windows compatible
- Twain compatible

Compatible systems 2

It is possible to process SXGA compatible images of this unit directly on a PC using a capture board. Images can be processed while viewing still images and camera video of this unit on a PC monitor.

- Images can be checked on a SXGA monitor when using an SXGA compatible capture board.
- Images can be checked on a VGA monitor when using a VGA compatible capture board.

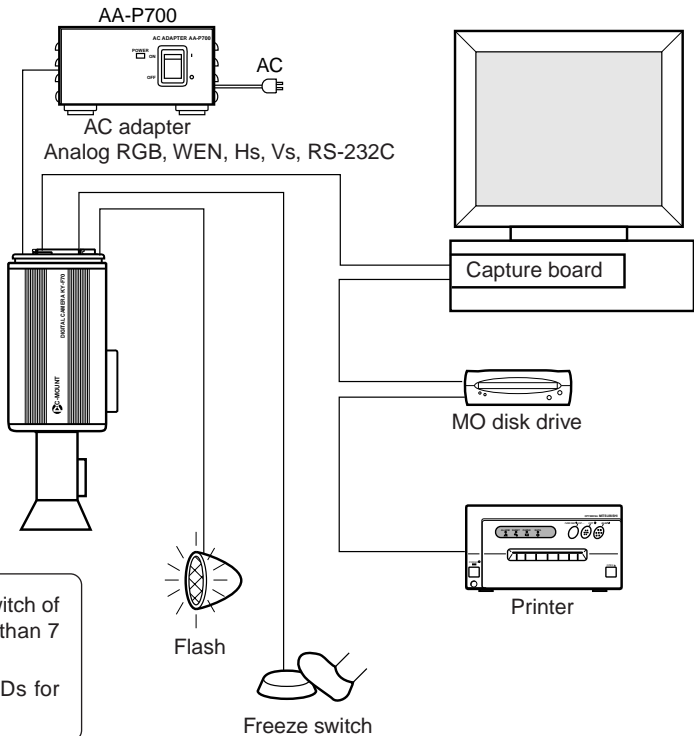

MEMO

- Set the SCSI ID dip switch of the main unit to other than 7 (☞ page 24).
- Do not use identical IDs for the setting ID.

* For this system, the attached camera remote control software must be installed to the PC. For details, see the attached instructions of the software.

8. Others

Specifications

Imaging device:	1/2 inch IT CCD × 3
Scanning method:	Progressive scanning
Available no. of pixels:	1.45 million pixels (1392 (H) × 1040 (V))
Effective no. of pixels:	1360 × 1024
Color separation method:	Dichroic prism method
Aspect ratio:	4:3
V.SCAN:	1/30 ~ 1/5906.8
Detail compensation method:	both H and V
Lens mount:	C mount
Analogue output:	R/G/B signal: 0.7V (p-p), 7.5 Ω
Output signals: (Choice of 1)	a 1360 × 1024 pixels, 7.5 frames/sec. b 640 × 480 pixels, 60 frames/sec. (screen update rate: 7.5 frames/sec., vertical resolution of 480 lines) c 640 × 280 pixels, 60 frames/sec. (screen update rate: 30 frames/sec., vertical resolution of 240 lines)
Synchronization method:	internal synchronization
Sync signal output:	Hs, Vs 3V (p-p) negative polarity
Digital output:	SCSI-2, 50-pin half-pitch SCSI connector
Output modes:	Can switch between target and initiator
Continuous no. of recording:	5 (4 when output mode is a)
Input power supply voltage:	DC 12V ⎓ (DC 10.5V to 15V ⎓)
Power consumption:	Approx. 15W
Weight:	Approx. 850g

External dimensions (unit: mm)

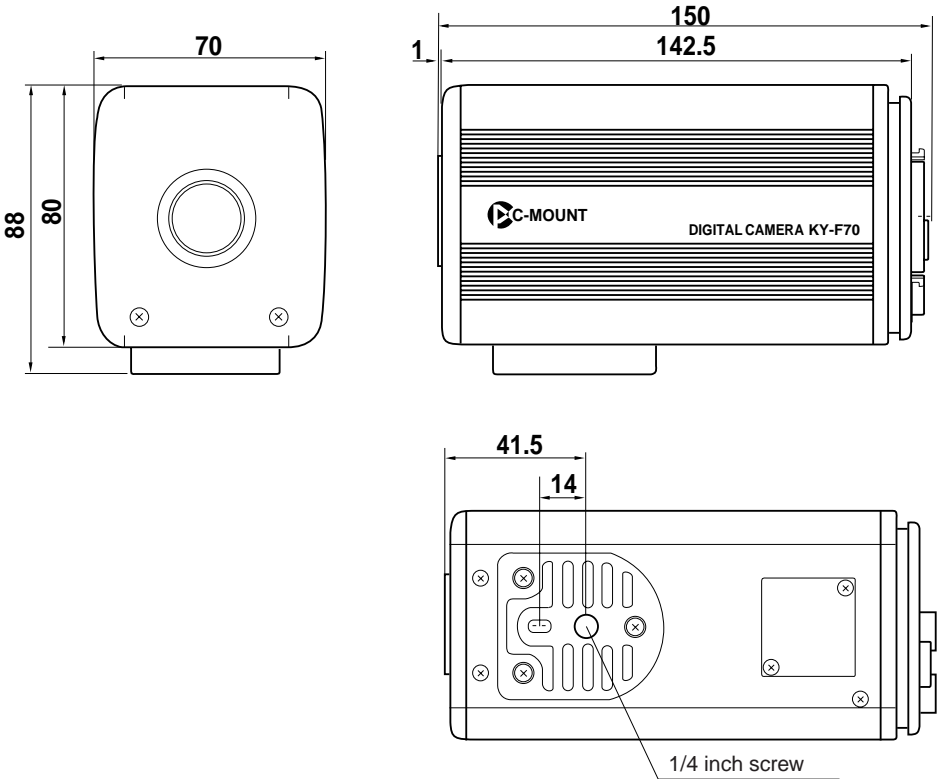

Design and specifications are subject to change without notice.



JVC® is a registered trademark owned by VICTOR COMPANY OF JAPAN, LTD.

JVC® is a registered trademark in Japan, the U.S.A., the U.K. and many other countries.

© 1999 VICTOR COMPANY OF JAPAN, LIMITED



Printed in Japan
SL96172